

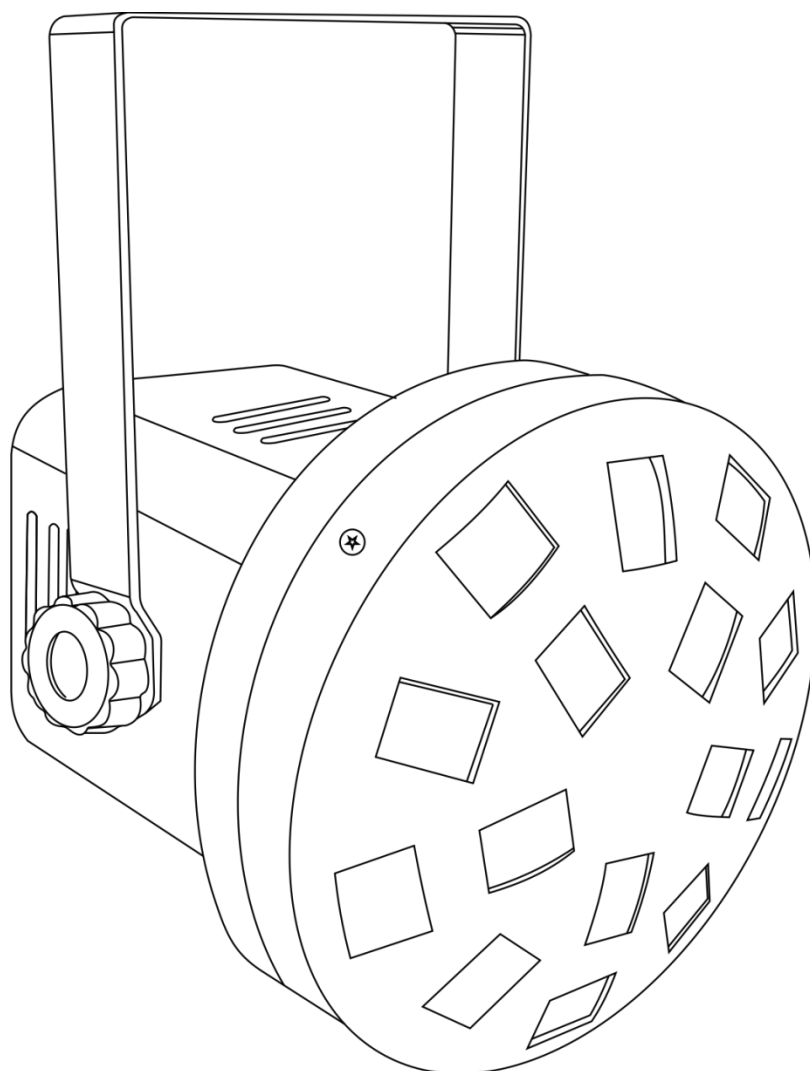

**MANUAL**



**ENGLISH**

**Bumper Mushroom**

**V1**

**Ordercode: 30871**

## Table of contents

---

<b>Warning</b> .....	2
Safety Instructions .....	2
Operating Determinations .....	4
Rigging .....	4
Connection with the mains.....	5
Return Procedure .....	6
Claims.....	6
<b>Description of the device</b> .....	7
Frontside.....	7
Backside .....	8
<b>Installation</b> .....	8
<b>Set Up and Operation</b> .....	8
Control Modes.....	9
One Bumper Mushroom (Static colors and Auto).....	9
One Bumper Mushroom (Sound-controlled).....	9
Remote Control.....	9
1. Static colors .....	10
2. Auto mode.....	10
3. Sound-controlled mode.....	10
<b>Maintenance</b> .....	11
Replacing the Fuse .....	11
<b>Troubleshooting</b> .....	11
No Light .....	11
<b>Product Specifications</b> .....	12
<b>Dimensions</b> .....	13

## Warning



**For your own safety, please read this user manual carefully  
before your initial start-up!**



## Unpacking Instructions

Immediately upon receiving this product, carefully unpack the carton and check the contents to ensure that all parts are present, and have been received in good condition. Notify the dealer immediately and retain packing material for inspection if any parts appear damaged from shipping or the carton itself shows signs of mishandling. Save the carton and all packing materials. In the event that a fixture must be returned to the factory, it is important that the fixture be returned in the original factory box and packing.

## Your shipment includes:

- Showtec Bumper Mushroom
- IEC power cable (1,5 m)
- IR remote control
- User manual

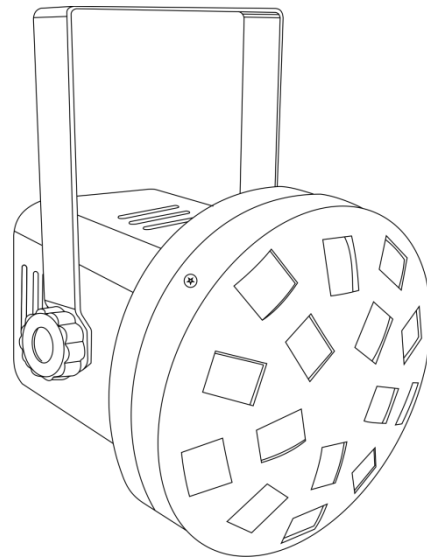

## LED Expected Lifespan

LEDs gradually decline in brightness over time. HEAT is the dominant factor that leads to the acceleration of this decline. Packaged in clusters, LEDs exhibit higher operating temperatures than in ideal or singular optimum conditions. For this reason, when all color LEDs are used at their fullest intensity, life of the LEDs is significantly reduced. If improving the lifespan is of higher priority, place care in providing for lower operational temperatures. This may include climatic-environmental and the reduction of overall projection intensity.



### CAUTION!

**Keep this device away from rain and moisture!  
Unplug mains lead before opening the housing!**



## Safety Instructions

Every person involved with the installation, operation and maintenance of this device has to:

- be qualified
- follow the instructions of this manual



**CAUTION! Be careful with your operations.  
With a dangerous voltage you can suffer  
a dangerous electric shock when touching the wires!**



Before the initial start-up, please make sure that there is no damage caused by transportation. Should there be any, consult your dealer and do not use the device.

To maintain perfect condition and to ensure a safe operation, it is absolutely necessary for the user to follow the safety instructions and warning notes contained in this manual.

Please consider that damages caused by manual modifications to the device are not subject to warranty.

This device contains no user-serviceable parts. Refer servicing to qualified technicians only.

### **IMPORTANT:**

The manufacturer will not accept liability for any resulting damages caused by the non-observance of this manual or any unauthorized modification to the device.

- Never let the power cord come into contact with other cables! Handle the power cord and all connections with the mains with particular caution!
- Never remove warning or informative labels from the unit.
- Never use anything to cover the ground contact.
- Never lift the fixture holding it by the projector head, as the mechanics may be damaged. Always hold the fixture by the transport handles.
- Never place any material over the lens.
- Never look directly into the light source.
- Never leave any cables lying around.
- Do not insert objects into air vents.
- Do not connect this device to a dimmerpack.
- Do not switch the device on and off in short intervals, as this will reduce the device's life.
- Do not touch the device's housing bare-handed during its operation (housing becomes very hot). Allow the fixture to cool for at least 5 minutes before handling.
- Do not shake the device. Avoid brute force when installing or operating the device.
- Only use the device indoors, avoid contact with water or other liquids.
- Only operate the fixture after having checked if the housing is firmly closed and all screws are tightly fastened.
- Only operate the device after having familiarized with its functions.
- Avoid flames and do not put close to flammable liquids or gases.
- Always keep the case closed while operating.
- Always allow a free air space of at least 50 cm around the unit for ventilation.
- Always disconnect power from the mains, when device is not used or before cleaning! Only handle the power cord holding it by the plug. Never pull out the plug by tugging the power cord.
- Make sure that the device is not exposed to extreme heat, moisture or dust.
- Make sure that the available voltage is not higher than stated on the rear panel.
- Make sure that the power cord is never crimped or damaged. Check the device and the power cord from time to time.
- If the lens is obviously damaged, it has to be replaced. So that its functions are not impaired, due to cracks or deep scratches.
- If device was dropped or struck, disconnect mains power supply immediately. Have a qualified engineer inspect for safety before operating.
- If the device has been exposed to drastic temperature fluctuation (e.g. after transportation), do not switch it on immediately. The arising condensation water might damage your device. Leave the device switched off until it has reached room temperature.
- If your Showtec device fails to work properly, discontinue the use immediately. Pack the unit securely (preferably in the original packing material), and return it to your Showtec dealer for service.
- For adult use only. The fixture must be installed beyond the reach of children. Never leave the unit running unattended.
- Never attempt to bypass the thermostatic switch or fuses.
- For replacement use fuses of same type and rating only.

- The user is responsible for correct positioning and operating of the Bumper Mushroom. The manufacturer will not accept liability for damages caused by the misuse or incorrect installation of this device.
- This device falls under protection class I. Therefore it is essential to connect the yellow/green conductor to earth.
- Repairs, servicing and electric connection must be carried out by a qualified technician.
- WARRANTY: Till one year after date of purchase.



### Operating Determinations

- This device is not designed for permanent operation. Consistent operation breaks will ensure that the device will serve you for a long time without defects.
- The minimum distance between light output and the illuminated surface must be bigger than 1 meter.
- The maximum ambient temperature  $t_a = 40^\circ\text{C}$  must never be exceeded.
- The relative humidity must not exceed 50 % with an ambient temperature of  $40^\circ\text{C}$ .
- If this device is operated in any other way than the one described in this manual, the product may suffer damages and the warranty becomes void.
- Any other operation may lead to dangers like short-circuit, burns, electric shock, crash, etc.

*You endanger your own safety and the safety of others!*

### Rigging

*Please follow the European and national guidelines concerning rigging, trussing and all other safety issues.*

*Do not attempt the installation yourself !*

*Always let the installation be carried out by an authorized dealer !*

### Procedure:

- If the projector is lowered from the ceiling or high joists, professional trussing systems have to be used.
- Use a clamp to mount the projector, with the mounting bracket, to the trussing system.
- The projector must never be fixed swinging freely in the room.
- The installation must always be secured with a safety attachment, e.g. an appropriate safety net or safety cable.
- When rigging, derigging or servicing the projector, always make sure, that the area below the installation site is secured and that there are not any unauthorized people around.

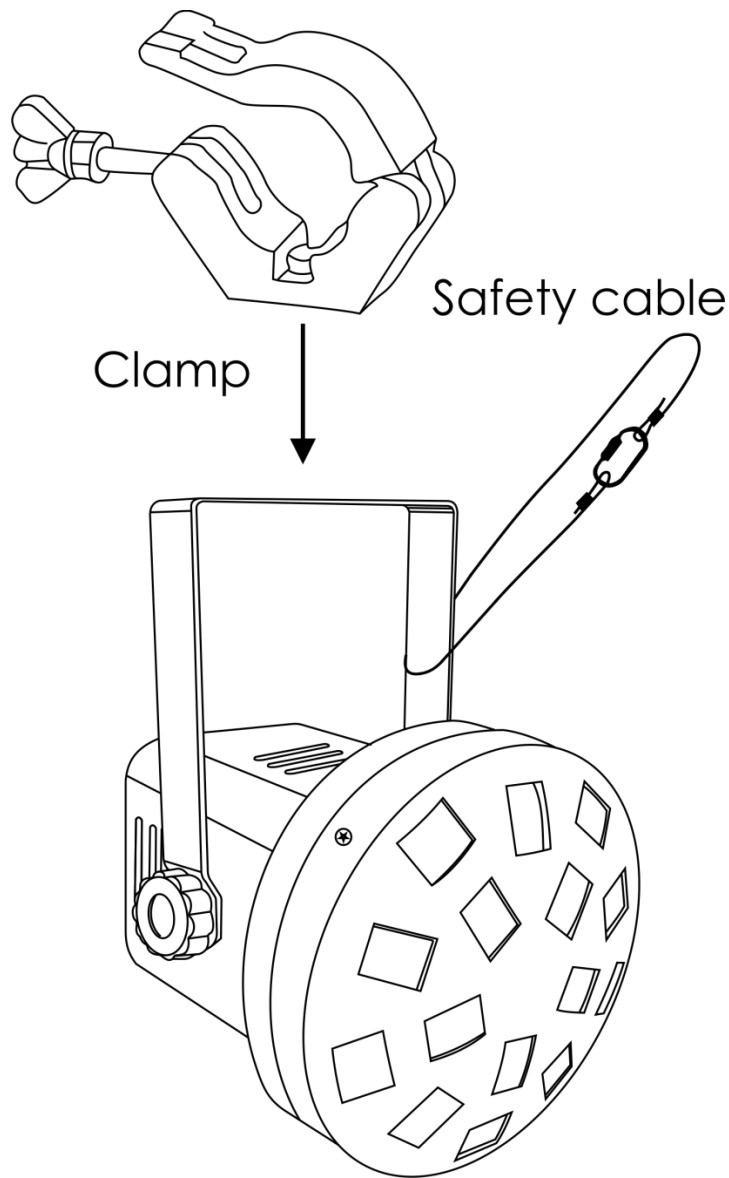

The Bumper Mushroom can be placed on a flat stage floor or mounted to any kind of truss with a clamp.

*Improper installation can cause serious injuries and/or damage of property!*

**Connection with the mains**

Connect the device to the mains with the power-plug.  
Always check if the right color cable is connected to the right place.

International	EU Cable	UK Cable	US Cable	Pin
L	BROWN	RED	YELLOW/COPPER	PHASE
N	BLUE	BLACK	SILVER	NEUTRAL
⊕	YELLOW/GREEN	GREEN	GREEN	PROTECTIVE GROUND

*Make sure that the device is always properly connected to the earth!*

*Improper installation can cause serious injuries and/or damage of property!*



### **Return Procedure**

Returned merchandise must be sent prepaid and in the original packing, call tags will not be issued. Package must be clearly labeled with a Return Authorization Number (RMA number). Products returned without an RMA number will be refused. Highlite will not accept the returned goods or any responsibility. Call Highlite 0031-455667723 or mail [offersales@highlite.nl](mailto:offersales@highlite.nl) and request an RMA prior to shipping the fixture. Be prepared to provide the model number, serial number and a brief description of the cause for the return. Be sure to properly pack fixture, any shipping damage resulting from inadequate packaging is the customer's responsibility. Highlite reserves the right to use its own discretion to repair or replace product(s). As a suggestion, proper UPS packing or double-boxing is always a safe method to use.

**Note: If you are given an RMA number, please include the following information on a piece of paper inside the box:**

- 01) Your name
- 02) Your address
- 03) Your phone number
- 04) A brief description of the symptoms

### **Claims**

The client has the obligation to check the delivered goods immediately upon delivery for any shortcomings and/or visible defects, or perform this check after our announcement that the goods are at their disposal. Damage incurred in shipping is the responsibility of the shipper; therefore the damage must be reported to the carrier upon receipt of merchandise.

It is the customer's responsibility to report and submit claims with the shipper in the event that a fixture is damaged due to shipping. Transportation damage has to be reported to us within one day after receipt of the delivery.

Any return shipment has to be made post-paid at all times. Return shipments must be accompanied with a letter defining the reason for return shipment. Non-prepaid return shipments will be refused, unless agreed otherwise in writing.

Complaints against us must be prepared in writing or sent by fax within 10 working days after receipt of the invoice. After this period complaints will not be handled anymore.

Complaints will only then be considered if the client has so far complied with all parts of the agreement, regardless of the agreement from which the obligation is resulting.

## Description of the device

### Features

The Bumper Mushroom is a light effect with high output and great effects.

- Input voltage: 100-240V AC, 60/50Hz
- Power consumption: 10W
- Light source: 1 x 1W Red LED, 1 x 1W Green LED, 1 x 1W Blue LED
- Control modes: Static colors, Auto, Sound-controlled
- Control: IR remote control
- Housing: Black metal & flame-retardant plastic
- Connections: IEC power connector IN
- Cooling: Convection
- Fuse: F1AL/250V
- Dimensions: 185 x 150 x 165 mm (LxWxH)
- Weight: 0,9 kg

### Frontside

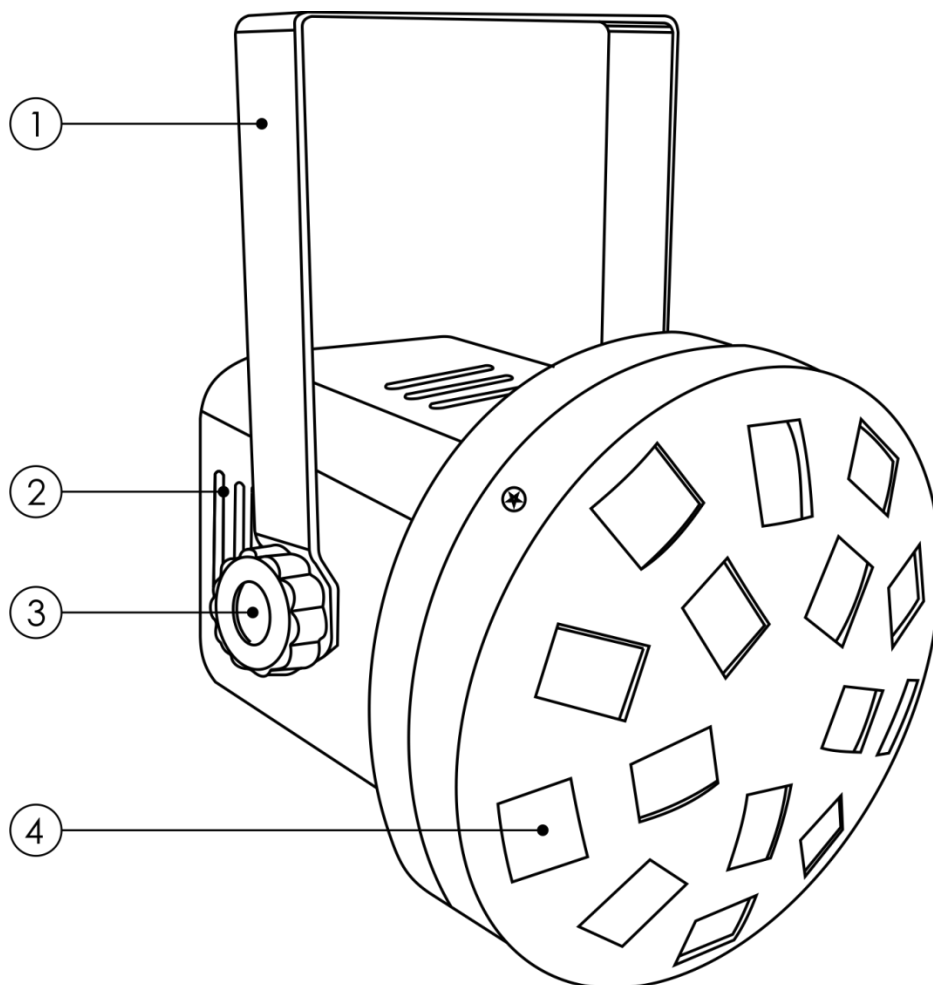

Fig. 01

- 01) Mounting bracket with inclination screw
- 02) Air-intake grill
- 03) Adjustment screw
- 04) 1 x 1W Red LED, 1 x 1W Green LED, 1 x 1W Blue LED



## Backside

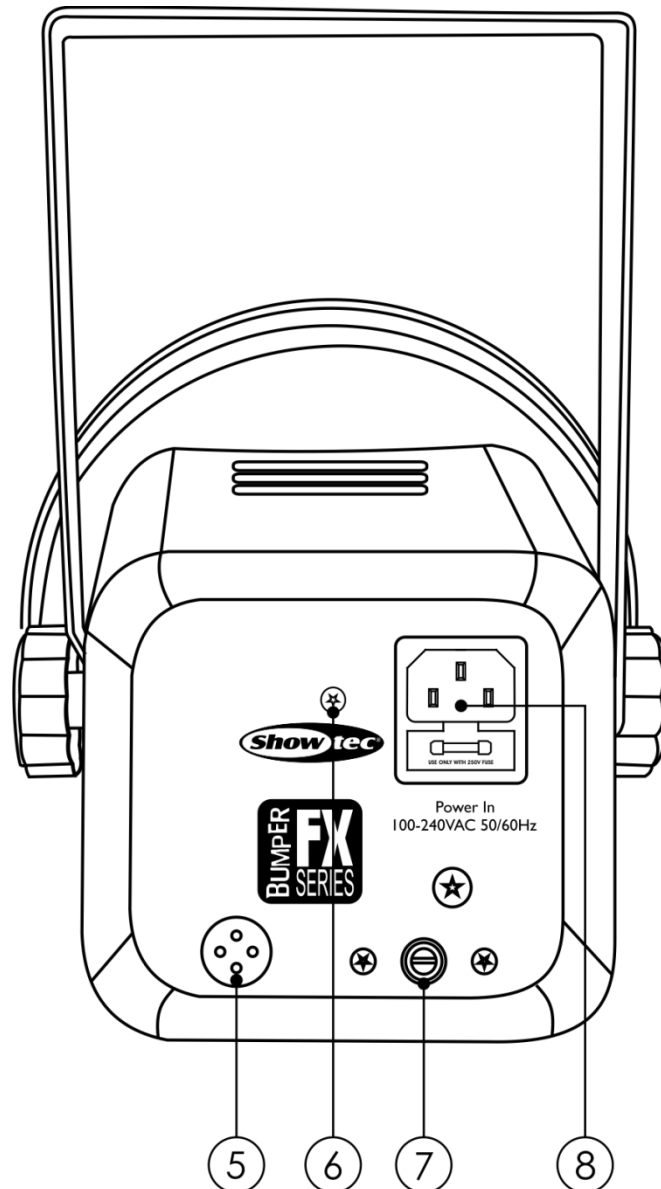

Fig. 02

- 05) Built-in microphone
- 06) Ground/earth connection
- 07) Sound sensitivity control
- 08) IEC power connector 100-240V IN + Fuse F1AL/250V

## Installation

Remove all packing materials from the Bumper Mushroom. Check if all foam and plastic padding is removed. Connect all cables.

**Do not supply power before the whole system is set up and connected properly.**

**Always disconnect from electric mains power supply before cleaning or servicing.**

**Damages caused by non-observance are not subject to warranty.**

## Set Up and Operation

Follow the directions below, as they pertain to your preferred operation mode.

Before plugging the unit in, always make sure that the power supply matches the product specification voltage. Do not attempt to operate a 120V specification product on 230V power, or vice versa.

Connect the device to the main power supply.

## Control Modes

- There are 3 modes:
- Static colors
  - Auto
  - Sound-controlled

### One Bumper Mushroom (Static colors and Auto)

- 01) Fasten the effect light to a firm trussing. Leave at least 0,5 meter on all sides for air circulation.
- 02) Always use a safety cable (ordercode 70140 / 70141).
- 03) Plug the end of the electric mains power cord into a proper electric power supply socket.
- 04) The Bumper Mushroom functions as a stand-alone device. See page 10 for more information about Static colors mode and Auto mode.

### One Bumper Mushroom (Sound-controlled)

- 01) Fasten the effect light to a firm trussing. Leave at least 0,5 meter on all sides for air circulation.
- 02) Always use a safety cable (ordercode 70140 / 70141).
- 03) Plug the end of the electric mains power cord into a proper electric power supply socket.
- 04) Turn on the music. If the device is set to sound-control, then the Bumper Mushroom will react to the beat of the music. Please see page 10 for more information about the sound-control options.

## Remote Control

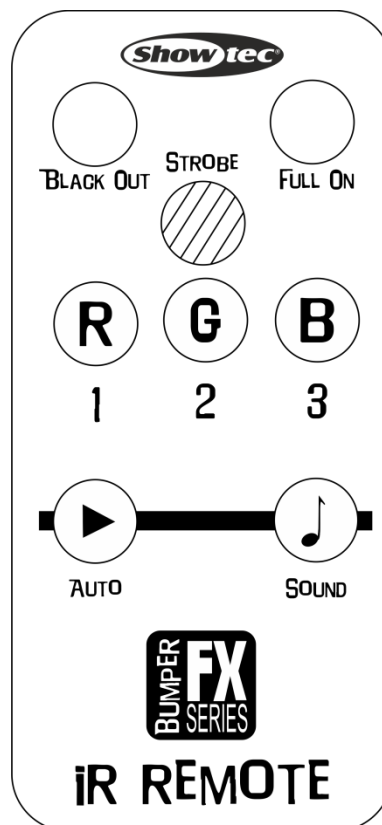



























Fig. 03

Button	Function	Description
	Blackout	Switch the LEDs OFF
	Auto mode	Activate Auto mode
	Sound-controlled mode	Activate Sound-controlled mode
	Static colors	Switch Red, Green and Blue ON or OFF
	Strobe	Activate strobe
	Full on	Switch the LEDs to FULL ON







## 1. Static colors

- 01) Press the    buttons to switch separate LEDs ON (Red, Green, Blue).
- 02) Press the  button to activate the strobe.
- 03) Press one of the    buttons to deactivate the strobe for the desired color.
- 04) Press one of the    buttons again to switch the desired color OFF.
- 05) Press the  button to switch ON all the LEDs, at once.
- 06) Press the  button to switch OFF all the LEDs, at once.

## 2. Auto mode

- 01) Press the  button to activate Auto mode.
- 02) The device will now run the built-in auto show.
- 03) Press the   , ,  or  buttons to deactivate Auto mode.

## 3. Sound-controlled mode

- 01) Press the  button to activate Sound-controlled mode.
- 02) Using a screwdriver, turn the sound sensitivity control **(07)** to the left or right, in order to decrease/increase the sound sensitivity.
- 03) Now the device will react to the beat of the background music.
- 04) Press the   , ,  or  buttons to deactivate Sound-controlled mode.

### Maintenance

---

The operator has to make sure that safety-related and machine-technical installations are to be inspected by an expert after every year in the course of an acceptance test.

The operator has to make sure that safety-related and machine-technical installations are to be inspected by a skilled person once a year.

The following points have to be considered during the inspection:

- 01) All screws used for installing the device or parts of the device have to be tightly connected and must not be corroded.
- 02) There may not be any deformations on housings, fixations and installation spots.
- 03) Mechanically moving parts like axles, eyes and others may not show any traces of wearing.
- 04) The electric power supply cables must not show any damages or material fatigue.

The Bumper Mushroom requires almost no maintenance. However, you should keep the unit clean. Otherwise, the fixture's light output will be significantly reduced. Disconnect the mains power supply, and then wipe the cover with a damp cloth. Do not immerse in liquid. Wipe lens clean with glass cleaner and a soft cloth. Do not use alcohol or solvents.

The front lens will require weekly cleaning, as smoke-fluid tends to build up residues, reducing the light-output very quickly.

Please clean internal components once a year with a light brush and vacuum cleaner.

### Replacing the Fuse

Power surges, short-circuit or inappropriate electrical power supply may cause a fuse to burn out. If the fuse burns out, the product will not function whatsoever. If this happens, follow the directions below.

- 01) Unplug the unit from electric power source.
- 02) Insert a screwdriver into the slot in the fuse cover. Gently pry up the fuse cover. The fuse will come out.
- 03) Remove the used fuse. If brown or unclear, it is burned out.
- 04) Insert the replacement fuse into the holder where the old fuse was. Reinsert the fuse cover. Be sure to use a fuse of the same type and specification. See the product specification label for details.

### Troubleshooting

---

This troubleshooting guide is meant to help solve simple problems.

If a problem occurs, carry out the steps below in sequence until a solution is found. Once the unit operates properly, do not carry out following steps.

#### No Light

If the light effect does not operate properly, refer servicing to a technician.

Suspect three potential problem areas as: the power supply, the LEDs, the fuse.

- 01) Power supply. Check that the unit is plugged into an appropriate power supply.
- 02) The LEDs. Return the Bumper Mushroom to your Showtec dealer.
- 03) The fuse. Replace the fuse. See page 11 for replacing the fuse.
- 04) If all of the above appears to be O.K., plug the unit in again.
- 05) If you are unable to determine the cause of the problem, do not open the Bumper Mushroom, as this may damage the unit and the warranty will become void.
- 06) Return the device to your Showtec dealer.

Problem	Probable cause(s)	Remedy
One or more fixtures do not function at all	No power to the fixture.	<ul style="list-style-type: none"> <li>Check if power is switched on and cables are plugged in.</li> </ul>
	Primary fuse blown.	<ul style="list-style-type: none"> <li>Replace fuse.</li> </ul>
No light or LEDs cuts out intermittently	Fixture is too hot.	<ul style="list-style-type: none"> <li>Allow fixture to cool.</li> <li>Clean fan.</li> <li>Make sure air vents are not blocked.</li> <li>Turn up the air conditioning .</li> </ul>
	LEDs damaged	<ul style="list-style-type: none"> <li>Disconnect fixture and return to your dealer.</li> </ul>
	The power supply settings do not match local AC voltage and frequency.	<ul style="list-style-type: none"> <li>Disconnect fixture. Check settings and correct if necessary.</li> </ul>

## Product Specifications

Model:	Showtec Bumper Mushroom
Input voltage:	100-240V AC, 60/50Hz
Power consumption:	10W (full output)
Fuse:	F1A/250V
Dimensions:	185 x 150 x 165 mm (LxWxH)
Weight:	0,9 kg
<b>Electro-mechanical effects:</b>	
Light source:	1 x 1W Red LED, 1 x 1W Green LED, 1 x 1W Blue LED
Housing:	Black Metal & flame-retardant plastic
Control modes:	Static colors, Auto, Sound-controlled
Control:	IR remote control
Connections:	Dedicated Schuko to IEC
Cooling:	Convection
Max. ambient temperature $t_a$ :	40°C
Max. housing temperature $t_b$ :	80°C
<b>Minimum distance:</b>	
Minimum distance from flammable surfaces:	0,5 m
Minimum distance to lighted object:	1 m

Design and product specifications are subject to change without prior notice.



Website: [www.Showtec.info](http://www.Showtec.info)

Email: [service@highlite.nl](mailto:service@highlite.nl)

Dimensions

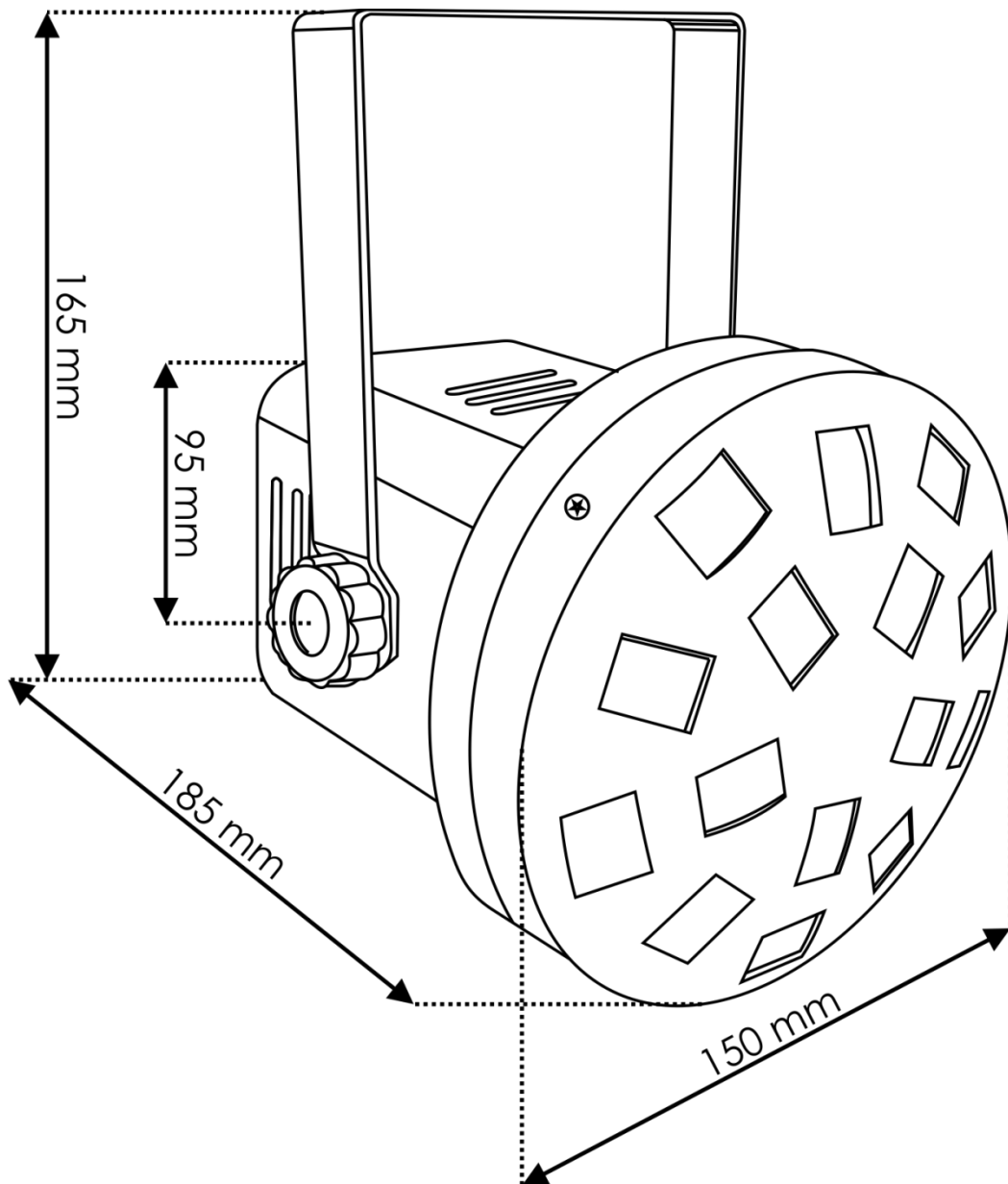





©2016 Showtec