

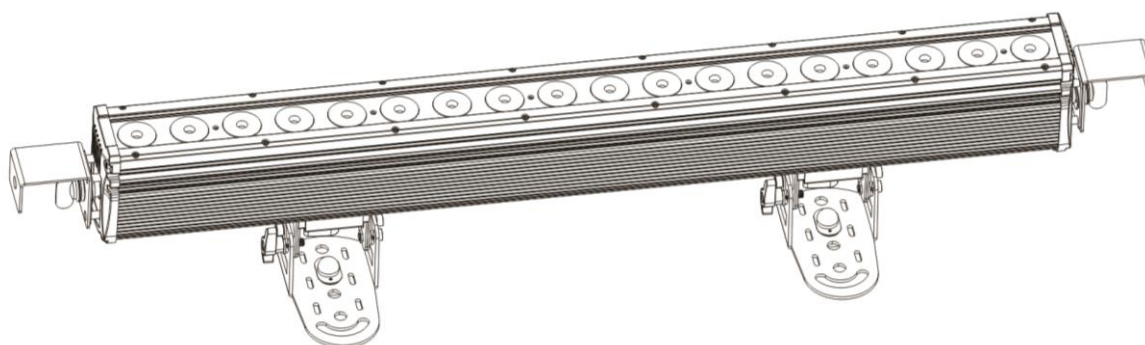

MANUAL



ENGLISH

Pixel Bar 18 Q4 Tour V2

Ordercode: 41302

Table of contents

Warning	2
Safety Instructions	2
Operating Determinations	4
Rigging	4
Connection with the mains.....	5
Return Procedure.....	5
Claims.....	5
Description of the device	6
Overview	7
Installation	8
Set Up and Operation	8
Control Modes.....	8
One Pixel Bar (Manual Control)	8
Multiple Pixel Bars (Master/Slave control)	8
Multiple Pixel Bars (DMX Control)	9
Fixture Linking.....	10
Data Cabling.....	10
Control Panel.....	11
Control Mode	11
DMX Addressing.....	11
Menu Overview.....	12
Main Menu Options.....	13
1. DMX Addressing.....	13
2. Slave Mode.....	13
3. Manual Color control.....	13
4. Sound-controlled.....	13
5. Settings.....	14
6. Built-in Programs.....	14
7. Auto Run Mode.....	15
DMX Channels	16
3 Channels	16
6 Channels	16
72 Channels	17
Maintenance	21
Replacing the Fuse	21
Troubleshooting	22
Product Specification	24

Warning



**For your own safety, please read this user manual carefully
before your initial start-up!**



Unpacking Instructions

Immediately upon receiving this product, carefully unpack the carton and check the contents to ensure that all parts are present, and have been received in good condition. Notify the dealer immediately and retain packing material for inspection if any parts appear damaged from shipping or the carton itself shows signs of mishandling. Save the carton and all packing materials. In the event that a fixture must be returned to the factory, it is important that the fixture be returned in the original factory box and packing.

Your shipment includes:

- Showtec Pixel Bar 18 Q4 Tour with blue Pro powercable 1,5m
- 2 brackets for truss mounting with quick locks
- User manual

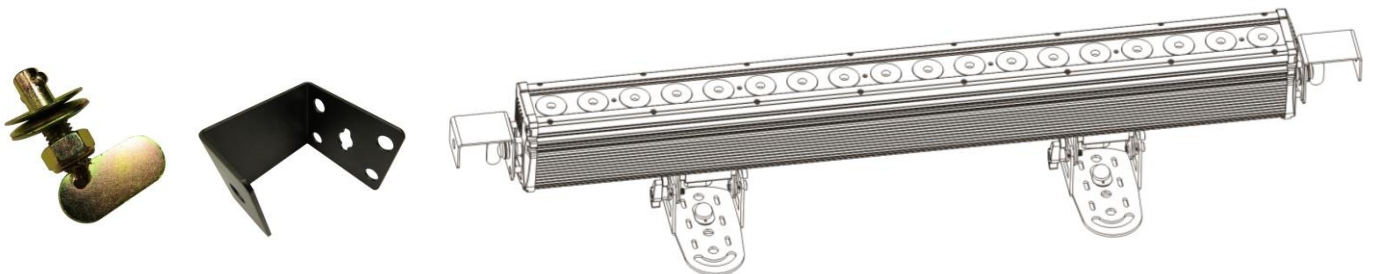

LED Expected Lifespan

LEDs gradually decline in brightness over time. HEAT is the dominant factor that leads to the acceleration of this decline. Packaged in clusters, LEDs exhibit higher operating temperatures than in ideal or singular optimum conditions. For this reason when all color LEDs are used at their fullest intensity, life of the LEDs is significantly reduced. If improving your lifespan expectancy is of a higher priority, place care in providing for lower operational temperatures. This may include climatic-environmental and the reduction of overall projection intensity



CAUTION!

**Keep this device away from rain and moisture!
Unplug mains lead before opening the housing!**



Safety Instructions

Every person involved with the installation, operation and maintenance of this device has to:

- be qualified
- follow the instructions of this manual



**CAUTION! Be careful with your operations.
With a dangerous voltage you can suffer
a dangerous electric shock when touching the wires!**



Before your initial start-up, please make sure that there is no damage caused by transportation. Should there be any, consult your dealer and do not use the device.

To maintain perfect condition and to ensure a safe operation, it is absolutely necessary for the user to follow the safety instructions and warning notes written in this manual.

Please consider that damages caused by manual modifications to the device are not subject to warranty.

This device contains no user-serviceable parts. Refer servicing to qualified technicians only.

IMPORTANT:

The manufacturer will not accept liability for any resulting damages caused by the non-observance of this manual or any unauthorized modification to the device.

- Never let the power-cord come into contact with other cables! Handle the power-cord and all connections with the mains with particular caution!
- Never remove warning or informative labels from the unit.
- Never use anything to cover the ground contact.
- Never place any material over the lens.
- Never look directly into the light source.
- Never leave any cables lying around.
- Do not insert objects into air vents.
- Do not connect this device to a dimmerpack.
- Do not switch the device on and off in short intervals, as this would reduce the device's life.
- Do not touch the device's housing bare-handed during its operation. Allow the fixture to cool for at least 5 minutes before handling.
- Do not shake the device. Avoid brute force when installing or operating the device.
- Only use device indoor, avoid contact with water or other liquids.
- Only operate the fixture after having checked that the housing is firmly closed and all screws are tightly fastened.
- Only operate the device after having familiarized with its functions.
- Avoid flames and do not put close to flammable liquids or gases.
- Always keep case closed while operating.
- Always allow free air space of at least 50 cm around the unit for ventilation.
- Always disconnect power from the mains, when device is not used or before cleaning! Only handle the power-cord by the plug. Never pull out the plug by tugging the power-cord.
- Make sure that the device is not exposed to extreme heat, moisture or dust.
- Make sure that the available voltage is not higher than stated on the rear panel.
- Make sure that the power-cord is never crimped or damaged. Check the device and the power-cord from time to time.
- If the lens is obviously damaged, it has to be replaced. So that its functions are not impaired, due to cracks or deep scratches.
- If device is dropped or struck, disconnect mains power supply immediately. Have a qualified engineer inspect for safety before operating.
- If the device has been exposed to drastic temperature fluctuation (e.g. after transportation), do not switch it on immediately. The arising condensation water might damage your device. Leave the device switched off until it has reached room temperature.
- If your Showtec device fails to work properly, discontinue use immediately. Pack the unit securely (preferably in the original packing material), and return it to your Showtec dealer for service.
- For adult use only. Device must be installed out of the reach of children. Never leave the unit running unattended.
- Never attempt to bypass the thermostatic switch or fuses.
- For replacement use fuses of same type and rating only.
- The user is responsible for correct positioning and operating of the Pixel Bar 18 Q4 Tour. The manufacturer will not accept liability for damages caused by the misuse or incorrect installation of this device.
- This device falls under protection class I. Therefore it is essential to connect the yellow/green conductor to earth.
- During the initial start-up some smoke or smell may arise. This is a normal process and does not necessarily mean that the device is defective.
- Repairs, servicing and electric connection must be carried out by a qualified technician.
- **WARRANTY:** Till one year after date of purchase.



CAUTION! Eyedamages!!!
Avoid looking directly into the lightsource!!!
(meant especially for epileptics)!!!



Operating Determinations

- This device is not designed for permanent operation. Consistent operation breaks will ensure that the device will serve you for a long time without defects.
- The minimum distance between light-output and the illuminated surface must be more than 1 meter.
- The maximum ambient temperature $t_a = 45^\circ\text{C}$ must never be exceeded.
- The relative humidity must not exceed 50 % with an ambient temperature of 40°C .
- If this device is operated in any other way, than the one described in this manual, the product may suffer damages and the warranty becomes void.
- Any other operation may lead to dangers like short-circuit, burns, electric shock, crash etc.

You endanger your own safety and the safety of others!

Rigging

Please follow the European and national guidelines concerning rigging, trussing and all other safety issues.

Do not attempt the installation yourself !

Always let the installation be carried out by an authorized dealer !

Procedure:

- If the projector is lowered from the ceiling or high joists, professional trussing systems have to be used.
- Use a clamp to mount the projector, with the mounting-bracket, to the trussing system.
- The projector must never be fixed swinging freely in the room.
- The installation must always be secured with a safety attachment, e.g. an appropriate safety net or safety-cable.
- When rigging, derigging or servicing the projector, always make sure, that the area below the installation place is blocked and staying in the area is forbidden.

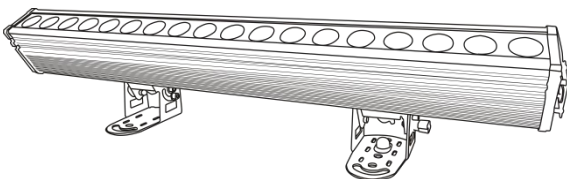

The Pixel Bar 18 Q4 Tour can be placed on a flat stage floor or mounted to any kind of truss by a clamp.

Improper installation can cause serious damage to people and property !

Connection with the mains

Connect the device to the mains with the power-plug.
Always pay attention, that the right color cable is connected to the right place.

International	EU Cable	UK Cable	US Cable	Pin
L	BROWN	RED	YELLOW/COPPER	FASE
N	BLUE	BLACK	SILVER	NULL
	YELLOW/GREEN	GREEN	GREEN	EARTH

Make sure that the device is always connected properly to the earth!



 **Return Procedure** 

Returned merchandise must be sent prepaid and in the original packing, call tags will not be issued. Package must be clearly labeled with a Return Authorization Number (RMA number). Products returned without an RMA number will be refused. Highlite will not accept the returned goods or any responsibility. Call Highlite 0031-455667723 or mail aftersales@highlite.nl and request an RMA prior to shipping the fixture. Be prepared to provide the model number, serial number and a brief description of the cause for the return. Be sure to properly pack fixture, any shipping damage resulting from inadequate packaging is the customer's responsibility. Highlite reserves the right to use its own discretion to repair or replace product(s). As a suggestion, proper UPS packing or double-boxing is always a safe method to use.

Note: If you are given an RMA number, please include the following information on a piece of paper inside the box:

- 01) Your name
- 02) Your address
- 03) Your phone number
- 04) A brief description of the symptoms

Claims

The client has the obligation to check the delivered goods immediately upon delivery for any short-comings and/or visible defects, or perform this check after our announcement that the goods are at their disposal. Damage incurred in shipping is the responsibility of the shipper; therefore the damage must be reported to the carrier upon receipt of merchandise.

It is the customer's responsibility to notify and submit claims with the shipper in the event that a fixture is damaged due to shipping. Transportation damage has to be reported to us within one day after receipt of the delivery.

Any return shipment has to be made post-paid at all times. Return shipments must be accompanied with a letter defining the reason for return shipment. Non-prepaid return shipments will be refused, unless otherwise agreed in writing.

Complaints against us must be made known in writing or by fax within 10 working days after receipt of the invoice. After this period complaints will not be handled anymore.

Complaints will only then be considered if the client has so far complied with all parts of the agreement, regardless of the agreement of which the obligation is resulting.

Description of the device

Features

The Showtec Pixel Bar 18 Q4 Tour is a compact and powerful fixture for both indoor and outdoor use.

- LED Quantity: 18x 4-in-1 8 Watt RGBW LEDs
- 3 DMX Modes: 3, 6 or 72 Channels
- Refresh rate: 3.0KHz
- RGBW Colormixing
- Pixel control
- Colour range: 16,7 million additive colors
- High Power Lightoutput
- IP20 Rating
- Specially designed housing ensures an optimum heat dissipation during operation
- Multiple mounting possibilities
- Input Voltage: 100-240 VAC, 50/60Hz
- Drive current: 450mA
- Power consumption: 170W max @FO (full output)
- Fixture Connection: XLR Data in/out (XLR 3-pin + XLR 5-pin)
- Pro power connector 100-240V in/out
- DMX-control via standard DMX-controller
- On Board: LCD Display for easy Set Up
- Control: DMX-512, Built-in Programs, Auto, Manual color, Master/Slave, Sound-controlled
- Mounting brackets included, which makes it easy to handle and position in truss systems
- Beam Angle: 18°
- Dimmer: 0-100%
- Strobe: 0-20Hz
- Housing: Die Cast Aluminum Powder Coat Finish
- Convection cooling which eliminates the use of fans and noise
- Cooling: Convection (no fans)
- Stylish design
- Operation temperature: -20~40°C
- Lens Plate: Tempered Glass
- Lux (@ 2 meter):
 - Red 1306
 - Green 2927
 - Blue 710
 - White 3117
 - RGBW 7420
- Fuse T2AL / 250V
- Dimensions: 1040 x 144 x 90 mm (LxWxH)
- Weight: 7,58 kg

Overview

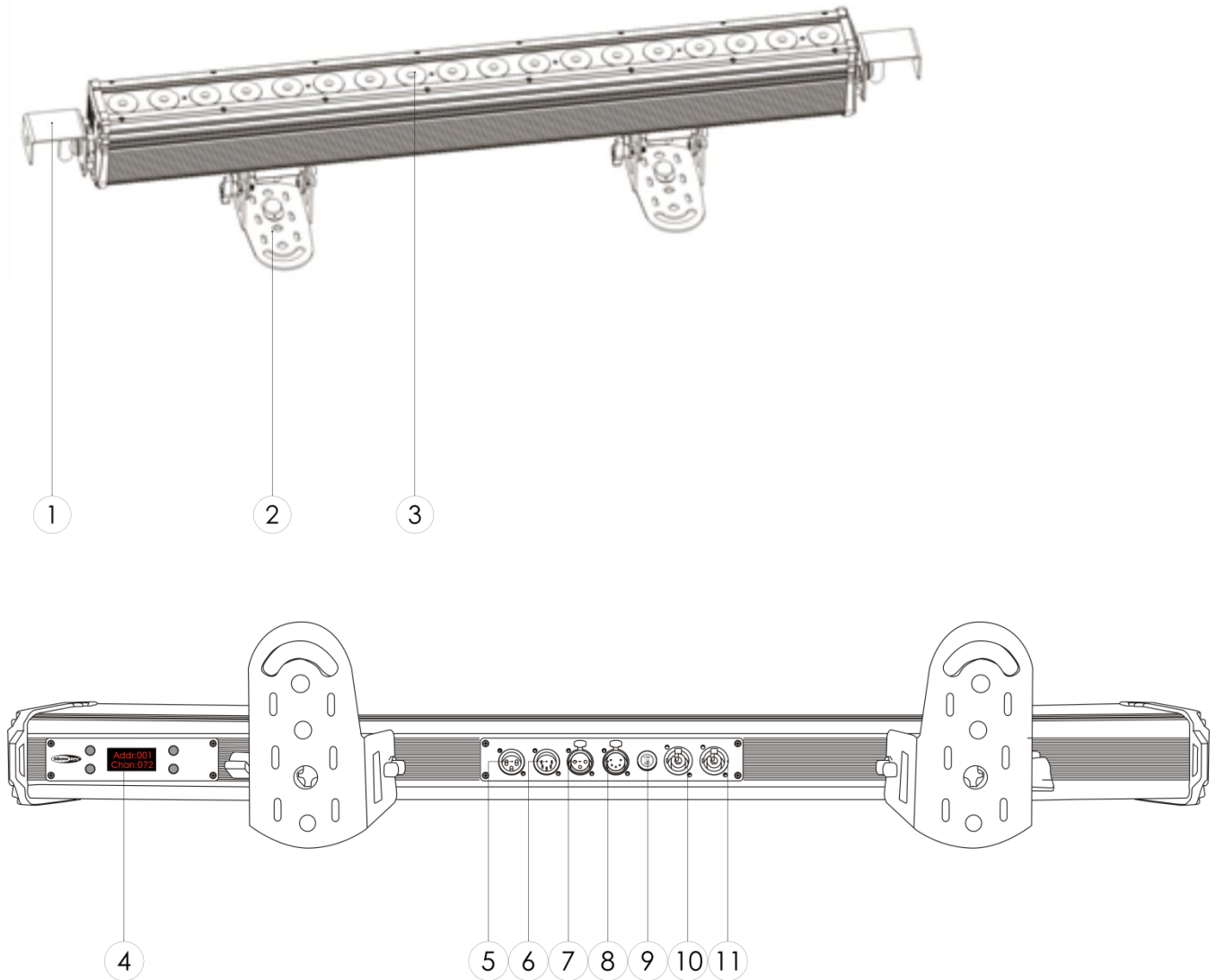

Fig. 01

- 01) Quicklock Mounting bracket
- 02) Quicklock Mounting bracket with inclination Screw
- 03) 18x 4-in-1 8 Watt RGBW LEDs
- 04) LCD Display + Mode, SETUP, UP, DOWN Buttons
- 05) DMX signal connector (IN) 3-pin
- 06) DMX signal connector (IN) 5-pin
- 07) DMX signal connector (OUT) 3-pin
- 08) DMX signal connector (OUT) 5-pin
- 09) Fuse T2AL / 250V
- 10) Blue Pro power connector 100-240V IN
- 11) Grey Pro power connector 100-240V Out

NOTE: Knowledge of DMX is required to fully utilize this unit.

Installation

Remove all packing materials from the Pixel Bar 18 Q4 Tour. Check that all foam and plastic padding is removed. Connect all cables.

Do not supply power before the whole system is set up and connected properly.

Always disconnect from electric mains power supply before cleaning or servicing.

Damages caused by non-observance are not subject to warranty.

Set Up and Operation

Follow the directions below, as they pertain to your preferred operation mode.

Before plugging the unit in, always make sure that the power supply matches the product specification voltage. Do not attempt to operate a 120V specification product on 230V power, or vice versa.

Control Modes

There are 6 modes:

- Stand-alone (Built-in Programs, Auto run, Static Colors)
- Sound-active
- Master/Slave
- DMX512 (3CH, 6CH or 72CH)

One Pixel Bar (Manual Control)

- 01) Fasten the effect light onto firm trussing. Leave at least 0,5 meter on all sides for air circulation.
- 02) Always use a safety cable (ordercode 70140 / 70141).
- 03) Plug the end of the electric mains power cord into a proper electric power supply socket.
- 04) When the Pixel Bar is not connected by a DMX-cable, it functions as a stand-alone device.
- 05) Please see page 13 for more information about the manual control functions.

Multiple Pixel Bars (Master/Slave control)

- 01) Fasten the effect light onto firm trussing. Leave at least 0,5 meter on all sides for air circulation.
- 02) Always use a safety cable (ordercode 70140 / 70141).
- 03) Plug the end of the electric mains power cord into a proper electric power supply socket.
- 04) Use a 3-p XLR cable to connect the Pixel Bar.

The pins:



1. Earth
2. Signal (-)
3. Signal (+)

- 05) Link the units as shown in (Fig. 02), Connect a DMX signal cable from the first unit's DMX "out" socket to the second unit's "in" socket. Repeat this process to link the second, third, and fourth units. You can use the same functions on the master device as described on page 13 (Manual Control or Music control). This means on the master device you can set your desired operation Mode and all slave devices will react the same as the master device.

Multiple Pixel Bars (Master/Slave control)

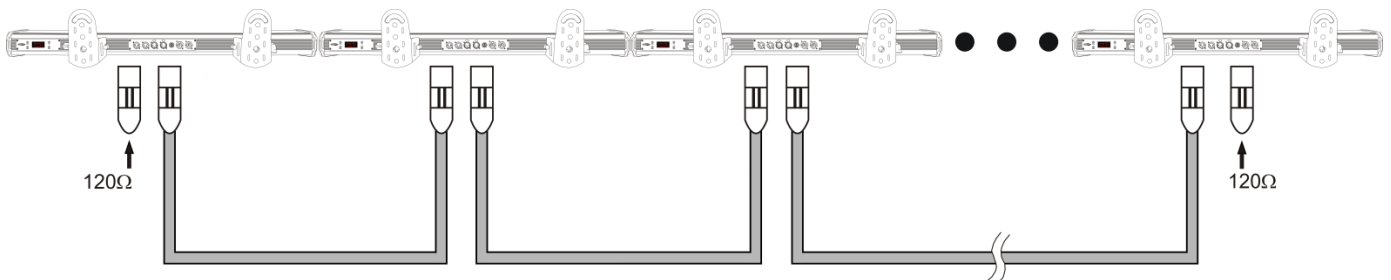
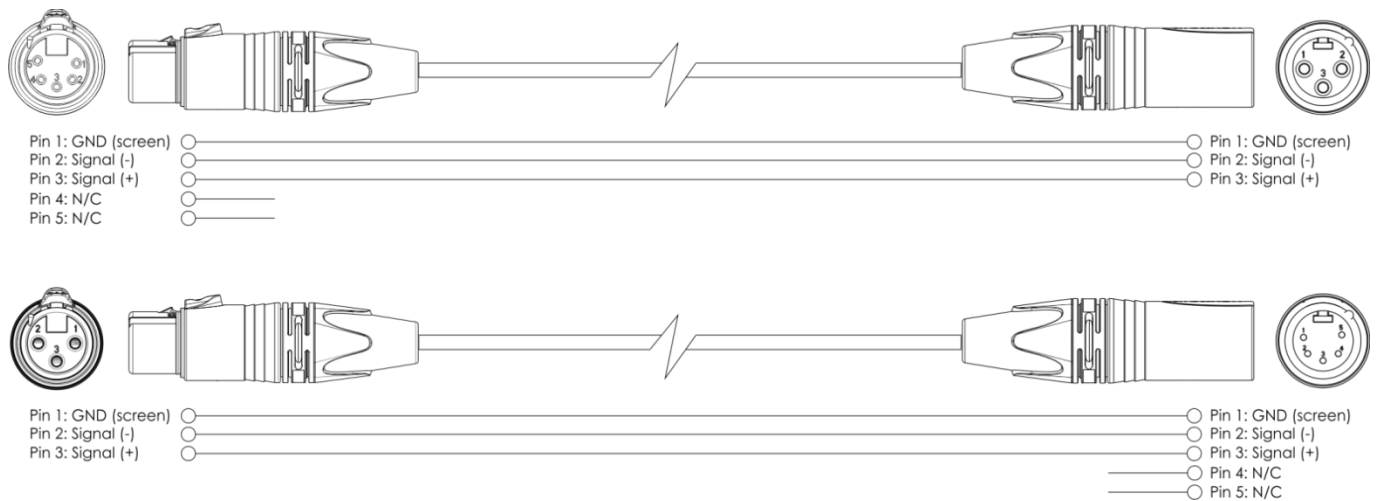

Fig. 02

Multiple Pixel Bars (DMX Control)

- 01) Fasten the effect light onto firm trussing. Leave at least 0,5 meter on all sides for air circulation.
- 02) Always use a safety cable (ordercode 70140 / 70141).
- 03) Plug the end of the electric mains power cord into a proper electric power supply socket.
- 04) Use a 3-p XLR cable to connect the Pixel Bars and other devices.



- 05) Link the units as shown in (figure 03), Connect a DMX signal cable from the first unit's DMX "out" socket to the second unit's "in" socket. Repeat this process to link the second, third, and fourth units.
- 06) Supply electric power: Plug electric mains power cords into each unit's Pro power connector socket, then plug the other end of the mains power cord into proper electric power supply sockets, starting with the first unit. Do not supply power before the whole system is set up and connected properly.

Multiple Pixel Bars DMX Set Up

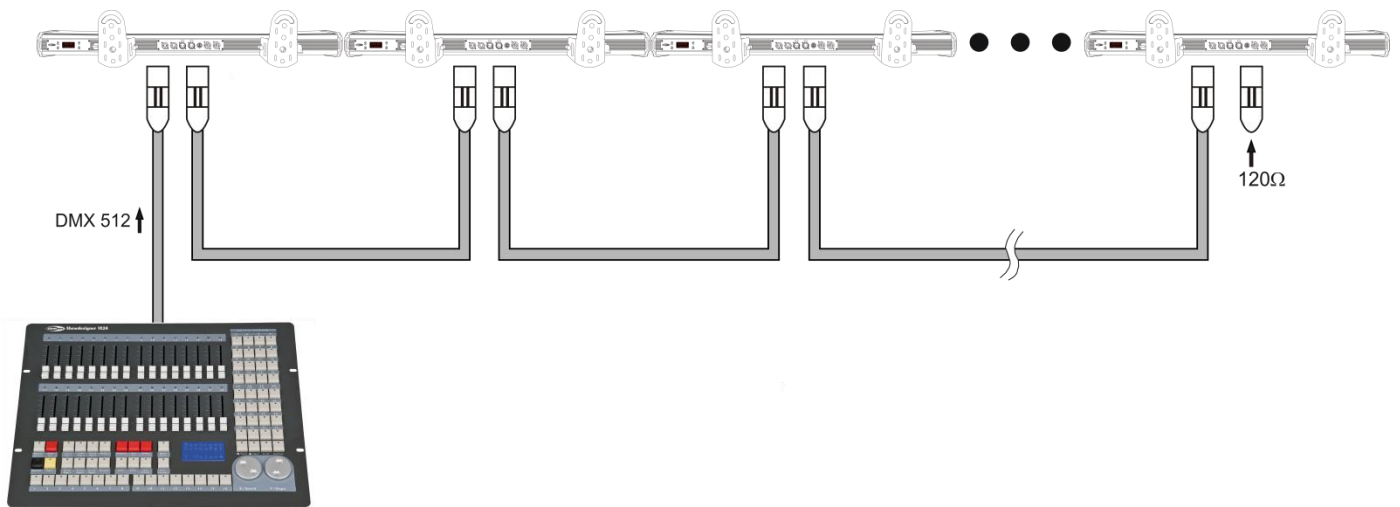

Fig. 03

Note : Link all cables before connecting electric power

Fixture Linking

You will need a serial data link to run light shows of one or more fixtures using a DMX-512 controller or to run synchronized shows on two or more fixtures set to a master/slave operating mode. The combined number of channels required by all the fixtures on a serial data link determines the number of fixtures the data link can support.

Important: Fixtures on a serial data link must be daisy chained in one single line. To comply with the EIA-485 standard no more than 30 devices should be connected on one data link. Connecting more than 30 fixtures on one serial data link without the use of a DMX optically isolated splitter may result in deterioration of the digital DMX signal.



Maximum recommended DMX data link distance: 100 meters

Maximum recommended number of Pixel Bars on a DMX data link: 30 fixtures

Maximum recommended number of Pixel Bars on a Powercon link: 2 fixtures @110V

Maximum recommended number of Pixel Bars on a Powercon link: 5 fixtures @240V

Data Cabling

To link fixtures together you must obtain data cables. You can purchase DAP Audio certified DMX cables directly from a dealer/distributor or construct your own cable. If you choose to create your own cable please use data-grade cables that can carry a high quality signal and are less prone to electromagnetic interference.

DAP Audio Certified DMX Data Cables

- DAP Audio Basic microphone cable for allround use. bal. XLR/M 3-pin > XLR/F 3-pin. **Ordercode** FL01150 (1,5 m), FL013 (3 m), FL016 (6 m), FL0110 (10 m), FL0115 (15 m), FL0120 (20 m).
- DAP Audio X-type data cable XLR/M 3-pin > XLR/F 3-pin. **Ordercode** FLX0175 (0,75 m), FLX01150 (1,5 m), FLX013 (3 m), FLX016 (6 m), FLX0110 (10 m).
- DAP Audio cable for the demanding user with exceptional audio-qualities and connector made by Neutrik®. **Ordercode** FL71150 (1,5 m), FL713 (3 m), FL716 (6 m), FL7110 (10 m).
- DAP Audio cable for the demanding user with exceptional audio-qualities and connector made by Neutrik®. **Ordercode** FL7275 (0,75 m), FL72150 (1,5 m), FL723 (3 m), FL726 (6 m), FL7210 (10 m).
- DAP Audio 110 Ohm cable with digital signal transmission. **Ordercode** FL0975 (0,75 m), FL09150 (1,5 m), FL093 (3 m), FL096 (6 m), FL0910 (10 m), FL0915 (15 m), FL0920 (20 m).

The Pixel Bar can be operated with a controller in **control mode** or without the controller in **stand-alone mode**.

Control Panel

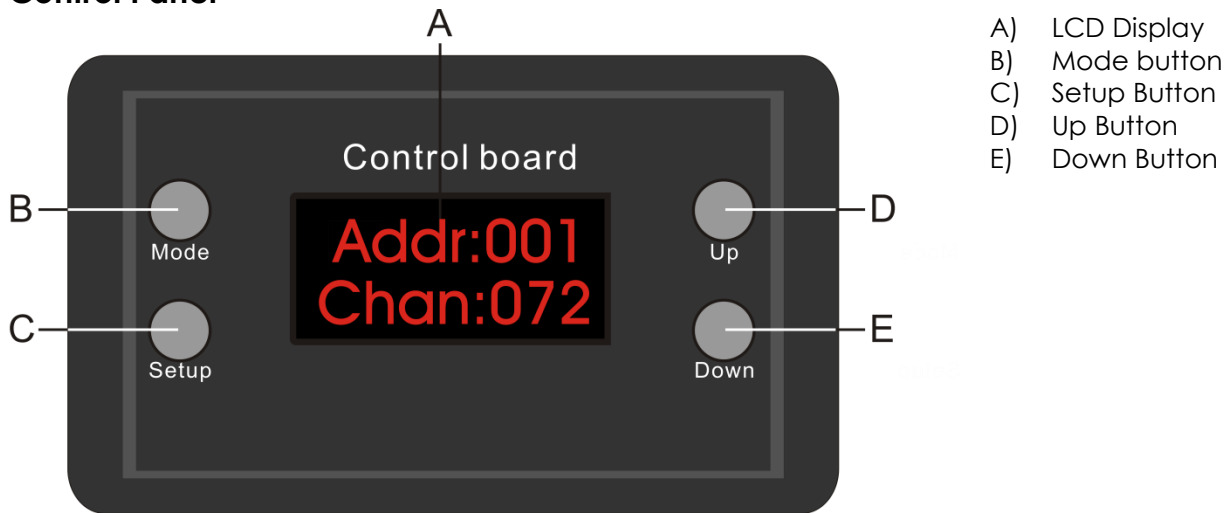

Fig. 04

Control Mode

The fixtures are individually addressed on a data-link and connected to the controller. The fixtures respond to the DMX signal from the controller.

DMX Addressing

The control panel on the front side of the base allows you to assign the DMX fixture address, which is the first channel from which the Pixel Bar will respond to the controller.

Please note when you use the controller, the unit has **72** channels.

When using multiple Pixel Bars, make sure you set the DMX addresses right.

Therefore, the DMX address of the first Pixel Bars should be **1(001)**; the DMX address of the second Pixel Bar should be **1+72=73 (073)**; the DMX address of the third Pixel Bar should be **73+72=145 (145)**, etc.

Please, be sure that you don't have any overlapping channels in order to control each Pixel Bar correctly.

If two or more Pixel Bars are addressed similarly, they will work similarly.

Controlling:

After having addressed all Pixel Bar fixtures, you may now start operating these via your lighting controller.

Note: After switching on, the Pixel Bar will automatically detect whether DMX 512 data is received or not.

If there is no data received at the DMX-input, the problem may be:

- The XLR cable from the controller is not connected with the input of the Pixel Bar.
- The controller is switched off or defective, the cable or connector is defective, or the signal wires are swapped in the input connector.

Note: It's necessary to insert a XLR termination plug (with 120 Ohm) in the last fixture in order to ensure proper transmission on the DMX data link.

⚠ Display Off after 30 seconds ⚠

When no button is pressed for 30 seconds, the display will turn off.





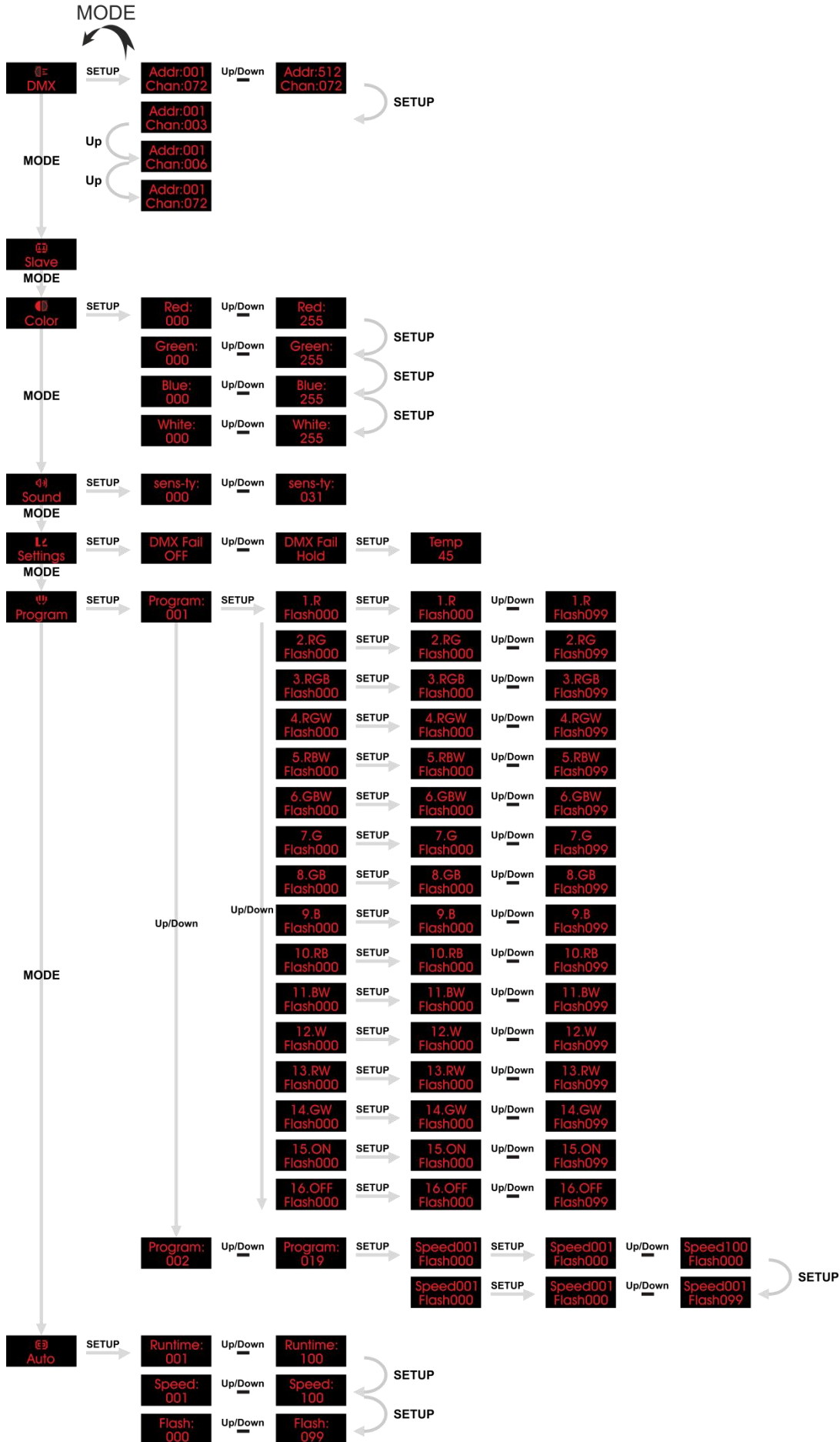

To light up the display, you have to press the MODE button.

Once you have pressed the button, the display will light up.

Menu Overview







Main Menu Options

	DMX address
	Master-Slave
	Manual Color
	Sound-controlled
	Settings
	Built-in Programs
	Auto run

1. DMX Addressing

With this menu you can set the DMX address.

- 01) Press the **MODE** button until the display shows .
- 02) Press the **SETUP** button to open this menu. You can choose 512 different DMX addresses.
- 03) Use the **UP/DOWN** buttons to select the required address from   .
- 04) Once you have set the desired DMX address, you can also choose the desired DMX Mode.
- 05) Press the **SETUP** button to set 3 different DMX Modes. Use the **UP/DOWN** buttons to choose between 3, 6 or 72 Channels.



2. Slave Mode













With this menu you can set the Master or Slave.

- 01) Press the **MODE** button until the display shows .
- 02) If the device has not been set to slave, it is automatically classified as a master device. All slave devices will follow the master movement.
- 03) If the device has been set to slave, it will react the same as its master device.

3. Manual Color control

With this menu you can you can manually set a desired color.





- 01) Press the **MODE** button until the display shows .
- 02) Press the **SETUP** button to open this menu.
- 03) You can use the **SETUP** button to scroll through the 4 color options.
- 04) Use the **UP/DOWN** buttons to change the values.

			Set the value of the red LEDs (0-255)
			Set the value of the green LEDs (0-255)
			Set the value of the blue LEDs (0-255)
			Set the value of the white LEDs (0-255)

You can combine Red, Green, Blue and White to create an infinite range of colors (0-255).





4. Sound-controlled

With this menu you can set the audio sensitivity.

- 01) Press the **MODE** button until the display shows .
- 02) Press the **SETUP** button to open this menu and set the sensitivity of the Pixel Bar 18 Q4 Tour.
- 03) Use the **UP/DOWN** buttons to select the required sensitivity from   .
- 04) Turn on the music and the Pixel Bar 18 Q4 Tour will react to the beat of the music







5. Settings

With this menu you can set the DMX Fail control.







- 01) Press the **MODE** button until the display shows .
- 02) Press the **SETUP** button to open this menu and set the DMX Fail control.
- 03) Use the **UP/DOWN** buttons to change the DMX Fail between  or .
- 04) Press the **SETUP** button to see the current operating temperature .

6. Built-in Programs

With this menu you can set the built-in programs.

- 01) Press the **MODE** button until the display shows .
- 02) Press the **SETUP** button to open this menu.
- 03) You can use the **UP/DOWN** button to scroll through the 19 built-in programs   .
- 04) When you select menu , you can use a wide variety of manual color settings.
- 05) Press the **SETUP** button to open menu . You can now set 15 preset colors and the flash frequency. In menu 16.OFF, the dimmer is set to 0, so the Flash will not work.

	→ SETUP →		Up/Down	
	→ SETUP →		Up/Down	
	→ SETUP →		Up/Down	
	→ SETUP →		Up/Down	
	→ SETUP →		Up/Down	
	→ SETUP →		Up/Down	
	→ SETUP →		Up/Down	
	→ SETUP →		Up/Down	
	→ SETUP →		Up/Down	
	→ SETUP →		Up/Down	
	→ SETUP →		Up/Down	
	→ SETUP →		Up/Down	
	→ SETUP →		Up/Down	
	→ SETUP →		Up/Down	
	→ SETUP →		Up/Down	
	→ SETUP →		Up/Down	









- 06) Press the **SETUP** button to open menu   . In menu   , you can switch between the Flash frequency and the Program Running Speed by pressing the **SETUP** button.
- 07) Use the **UP/DOWN** buttons to change the values.



7. Auto Run Mode

With this menu you can set Auto Run mode of the Pixel Bar.

- 01) Press the **MODE** button until the display shows .
- 02) You can use the **SETUP** button to scroll through the 3 options.
- 03) Use the **UP/DOWN** buttons to change the values.

			Set the Number of Loops (001-100)
			Set the speed value (01-99+Full)
			Set the value of the Flash frequency (0-99)

DMX Channels

3 Channels

Channel 1 – Built-in Programs

0	OFF
1-12	Program 01
13-25	Program 02
26-38	Program 03
39-51	Program 04
52-64	Program 05
65-77	Program 06
78-90	Program 07
91-103	Program 08
104-116	Program 09
117-129	Program 10
130-142	Program 11
143-155	Program 12
156-168	Program 13
169-181	Program 14
182-194	Program 15
195-207	Program 16
208-220	Program 17
221-233	Program 18
234-255	Sound-controlled

Channel 2 – Program Speed (CH1 must be set between 1-233)

0	Open
1-255	From minimum Speed (0) to maximum Speed (255)

Channel 2 – Audio Sensitivity (CH1 must be set between 234-255)

0-255	From minimum Sensitivity (0) to maximum Sensitivity (255)
-------	---

Channel 3 – Shutter / Strobe (CH1 must be set between 1-233)

0	Open
1-255	Strobe effect, from slow to fast (0-20 flashes/sec.)

Channel 3 – No function when CH1 must be set between 234-255)

6 Channels

Channel 1 – Red Dimmer intensity

0-255	Red from 0 – 100%
-------	-------------------

Channel 2 – Green Dimmer intensity

0-255	Green from 0 – 100%
-------	---------------------

Channel 3 – Blue Dimmer intensity

0-255	Blue from 0 – 100%
-------	--------------------

Channel 4 – White Dimmer intensity

0-255	White from 0 – 100%
-------	---------------------

Channel 5 – Master Dimmer

0-255	From black to brightest
-------	-------------------------

Channel 6 – Shutter / Strobe (CH1, CH2, CH3, CH4 or CH5 must be set between 1-255 )

- 0 Open
- 1-255 Strobe effect, from slow to fast (0-20 flashes/sec.)

72 Channels

Channel 1 – Red Dimmer intensity
0-255 Red from 0 – 100%



Channel 2 – Green Dimmer intensity
0-255 Green from 0 – 100%



Channel 3 – Blue Dimmer intensity
0-255 Blue from 0 – 100%



Channel 4 – White Dimmer intensity
0-255 White from 0 – 100%



Channel 5 – Red Dimmer intensity
0-255 Red from 0 – 100%



Channel 6 – Green Dimmer intensity
0-255 Green from 0 – 100%



Channel 7 – Blue Dimmer intensity
0-255 Blue from 0 – 100%



Channel 8 – White Dimmer intensity
0-255 White from 0 – 100%



Channel 9 – Red Dimmer intensity
0-255 Red from 0 – 100%



Channel 10 – Green Dimmer intensity
0-255 Green from 0 – 100%



Channel 11 – Blue Dimmer intensity
0-255 Blue from 0 – 100%



Channel 12 – White Dimmer intensity
0-255 White from 0 – 100%



Channel 13 – Red Dimmer intensity
0-255 Red from 0 – 100%



Channel 14 – Green Dimmer intensity
0-255 Green from 0 – 100%



Channel 15 – Blue Dimmer intensity
0-255 Blue from 0 – 100%



Channel 16 – White Dimmer intensity
0-255 White from 0 – 100%



Channel 17 – Red Dimmer intensity
0-255 Red from 0 – 100%



Channel 18 – Green Dimmer intensity

0-255 Green from 0 – 100%



Channel 19 – Blue Dimmer intensity

0-255 Blue from 0 – 100%



Channel 20 – White Dimmer intensity

0-255 White from 0 – 100%



Channel 21 – Red Dimmer intensity

0-255 Red from 0 – 100%



Channel 22 – Green Dimmer intensity

0-255 Green from 0 – 100%



Channel 23 – Blue Dimmer intensity

0-255 Blue from 0 – 100%



Channel 24 – White Dimmer intensity

0-255 White from 0 – 100%



Channel 25 – Red Dimmer intensity

0-255 Red from 0 – 100%



Channel 26 – Green Dimmer intensity

0-255 Green from 0 – 100%



Channel 27 – Blue Dimmer intensity

0-255 Blue from 0 – 100%



Channel 28 – White Dimmer intensity

0-255 White from 0 – 100%



Channel 29 – Red Dimmer intensity

0-255 Red from 0 – 100%



Channel 30 – Green Dimmer intensity

0-255 Green from 0 – 100%



Channel 31 – Blue Dimmer intensity

0-255 Blue from 0 – 100%



Channel 32 – White Dimmer intensity

0-255 White from 0 – 100%



Channel 33 – Red Dimmer intensity

0-255 Red from 0 – 100%



Channel 34 – Green Dimmer intensity

0-255 Green from 0 – 100%



Channel 35 – Blue Dimmer intensity

0-255 Blue from 0 – 100%



Channel 36 – White Dimmer intensity

0-255 White from 0 – 100%



Channel 37 – Red Dimmer intensity

0-255 Red from 0 – 100%



Channel 38 – Green Dimmer intensity

0-255 Green from 0 – 100%



Channel 39 – Blue Dimmer intensity

0-255 Blue from 0 – 100%



Channel 40 – White Dimmer intensity

0-255 White from 0 – 100%



Channel 41 – Red Dimmer intensity

0-255 Red from 0 – 100%



Channel 42 – Green Dimmer intensity

0-255 Green from 0 – 100%



Channel 43 – Blue Dimmer intensity

0-255 Blue from 0 – 100%



Channel 44 – White Dimmer intensity

0-255 White from 0 – 100%



Channel 45 – Red Dimmer intensity

0-255 Red from 0 – 100%



Channel 46 – Green Dimmer intensity

0-255 Green from 0 – 100%



Channel 47 – Blue Dimmer intensity

0-255 Blue from 0 – 100%



Channel 48 – White Dimmer intensity

0-255 White from 0 – 100%



Channel 49 – White Dimmer intensity

0-255 White from 0 – 100%



Channel 50 – White Dimmer intensity

0-255 White from 0 – 100%



Channel 51 – Red Dimmer intensity

0-255 Red from 0 – 100%



Channel 52 – Green Dimmer intensity

0-255 Green from 0 – 100%



Channel 53 – Blue Dimmer intensity

0-255 Blue from 0 – 100%



Channel 54 – White Dimmer intensity

0-255 White from 0 – 100%



Channel 55 – Red Dimmer intensity

0-255 Red from 0 – 100%



Channel 56 – Green Dimmer intensity

0-255 Green from 0 – 100%



Channel 57 – Red Dimmer intensity

0-255 Blue from 0 – 100%



Channel 58 – Green Dimmer intensity

0-255 White from 0 – 100%



Channel 59 – Green Dimmer intensity

0-255 Red from 0 – 100%



Channel 60 – White Dimmer intensity

0-255 Green from 0 – 100%



Channel 61 – Red Dimmer intensity

0-255 Red from 0 – 100%



Channel 22 – Green Dimmer intensity

0-255 Green from 0 – 100%



Channel 63 – Blue Dimmer intensity

0-255 Blue from 0 – 100%



Channel 64 – White Dimmer intensity

0-255 White from 0 – 100%



Channel 65 – Red Dimmer intensity

0-255 Red from 0 – 100%



Channel 66 – Green Dimmer intensity

0-255 Green from 0 – 100%



Channel 67 – Blue Dimmer intensity

0-255 Blue from 0 – 100%



Channel 68 – White Dimmer intensity

0-255 White from 0 – 100%



Channel 69 – Red Dimmer intensity

0-255 Red from 0 – 100%



Channel 70 – Green Dimmer intensity

0-255 Green from 0 – 100%



Channel 71 – Blue Dimmer intensity

0-255 Blue from 0 – 100%



Channel 72 – White Dimmer intensity

0-255 White from 0 – 100%



Maintenance

The Showtec Pixel Bar requires almost no maintenance. However, you should keep the unit clean. Otherwise, the fixture's light-output will be significantly reduced. Disconnect the mains power supply and then wipe the cover with a damp cloth. Wipe the front glass panel clean with glass cleaner and a soft cloth. Do not use alcohol or solvents. The front glass panel will require weekly cleaning, as smoke-fluid tends to build up residues, reducing the light-output very quickly. Do not immerse in liquid. Keep connections clean. Disconnect electric power, and then wipe the DMX and audio connections with a damp cloth. Make sure connections are thoroughly dry before linking equipment or supplying electric power.

The operator has to make sure that safety-relating and machine-technical installations are to be inspected by an expert after every year in the course of an acceptance test.

The operator has to make sure that safety-relating and machine-technical installations are to be inspected by a skilled person once a year.

The following points have to be considered during the inspection:

- 01) All screws used for installing the device or parts of the device have to be tightly connected and must not be corroded.
- 02) There may not be any deformations on housings, fixations and installation spots.
- 03) Mechanically moving parts like axles, eyes and others may not show any traces of wearing.
- 04) The electric power supply cables must not show any damages or material fatigue.

Replacing the Fuse

Power surges, short-circuit or inappropriate electrical power supply may cause a fuse to burn out. If the fuse burns out, the product will not function whatsoever. If this happens, follow the directions below:

- 01) Unplug the unit from electric power source.
- 02) Insert a flat-head screwdriver into a slot in the fuse cover. Turn the screwdriver to the left, at the same time gently push a bit (Turn and Push). The fuse will come out.
- 03) Remove the used fuse. If brown or unclear, it is burned out.
- 04) Insert the replacement fuse into the holder where the old fuse was. Reinsert the fuse cover. Be sure to use a fuse of the same type and specification. See the product specification label for details.

Troubleshooting

No Light

This troubleshooting guide is meant to help solve simple problems.

If a problem occurs, carry out the steps below in sequence until a solution is found. Once the unit operates properly, do not carry out following steps.

If the light effect does not operate properly, refer servicing to a technician.

Response: Suspect three potential problem areas as: the power supply, the LED, the fuse.

- 01) Power supply. Check that the unit is plugged into an appropriate power supply.
- 02) The LEDs. Return the Pixel Bar to your Showtec dealer.
- 03) The fuse. Replace the fuse. See page 21 for replacing the fuse.
- 04) If all of the above appears to be O.K., plug the unit in again.
- 05) If you are unable to determine the cause of the problem, do not open the Pixel Bar, as this may damage the unit and the warranty will become void.
- 06) Return the device to your Showtec dealer.

No Response to DMX

Response: Suspect the DMX cable or connectors, a controller malfunction, a light effect DMX card malfunction.

- 01) Check the DMX setting. Make sure that DMX addresses are correct.
- 02) Check the DMX cable: Unplug the unit; change the DMX cable; then reconnect to electrical power. Try your DMX control again.
- 03) Determine whether the controller or light effect is at fault. Does the controller operate properly with other DMX products ? If not, take the controller in for repair. If so, take the DMX cable and the light effect to a qualified technician.

See next page for more problem solving.

Problem	Probable cause(s)	Remedy
One or more fixtures are completely dead.	No power to the fixture	<ul style="list-style-type: none"> • Check that power is switched on and cables are plugged in.
	Primary fuse blown	<ul style="list-style-type: none"> • Replace fuse
Fixtures reset correctly, but all respond erratically or not at all to the controller.	The controller is not connected.	<ul style="list-style-type: none"> • Connect controller.
	3-pin XLR Out of the controller does not match XLR Out of the first fixture on the link (i.e. signal is reversed).	<ul style="list-style-type: none"> • Install a phase reversing cable between the controller and the first fixture on the link.
Fixtures reset correctly, but some respond erratically or not at all to the controller.	Poor data quality	<ul style="list-style-type: none"> • Check data quality. If much lower than 100 percent, the problem may be a bad data link connection, poor quality or broken cables, missing termination plug, or a defective fixture disturbing the link.
	Bad data link connection	<ul style="list-style-type: none"> • Inspect connections and cables. Correct poor connections. Repair or replace damaged cables.
	Data link not terminated with 120 Ohm termination plug.	<ul style="list-style-type: none"> • Insert termination plug in output jack of the last fixture on the link.
	Incorrect addressing of the fixtures.	<ul style="list-style-type: none"> • Check address setting.
	One of the fixtures is defective and disturbs data transmission on the link.	<ul style="list-style-type: none"> • Bypass one fixture at a time until normal operation is regained: unplug both connectors and connect them directly together. • Have the defective fixture serviced by a qualified technician.
	3-pin XLR Out on the fixtures does not match (pins 2 and 3 reversed).	<ul style="list-style-type: none"> • Install a phase-reversing cable between the fixtures or swap pin 2 and 3 in the fixture, that behaves erratically.
Shutter closes suddenly	The color wheel, gobowheel or a gobo has lost its index position and the fixture is resetting the effect.	<ul style="list-style-type: none"> • Contact a technician for servicing the problem persists.
No light or lamp cuts out intermittently	Fixture is too hot.	<ul style="list-style-type: none"> • Allow fixture to cool. • Make sure air vents at control panel and front lens are not blocked. • Turn up the air conditioning .
	LEDs damaged	<ul style="list-style-type: none"> • Disconnect fixture and return to your dealer.
	The power supply settings do not match local AC voltage and frequency.	<ul style="list-style-type: none"> • Disconnect fixture. Check settings and correct if necessary.

Product Specification

Model:	Showtec Pixel Bar 18 Q4 Tour
Input Voltage:	100-240 VAC
Drive current:	450mA
Continuous Power:	170W max @FO (full output)
Fuse	T2AL / 250V
Dimensions:	1040 x 90 x 144 mm (LxWxH)
Weight:	7,58 kg
Operation and Programming	
Signal pin OUT:	pin 1 earth, pin 2 (-), pin 3 (+)
Set Up and Addressing:	LED control panel
DMX Channels:	3, 6 or 72
Signal input:	3-pin + 5-pin XLR male
Signal output:	3-pin + 5-pin XLR female
Electro-mechanical effects	
<ul style="list-style-type: none"> • LED Quantity: 18x 4-in-1 8 Watt RGBW LEDs • RGBW Colormixing • Colour range: 16,7 million additive colors • Neutrik Powercon in/out • Refresh rate: 3.0KHz • Pixel control • High Power Lightoutput • IP20 Rating • Specially designed housing ensures an optimum heat dissipation during operation • Multiple mounting possibilities • DMX-control via standard DMX-controller • On Board: Display for easy Set Up • Control: DMX-512, Built-in Programs, Auto, Manual color, Master/Slave, Sound-controlled • Mounting brackets included, which makes it easy to handle and position in truss systems • Beam Angle: 18° • Dimmer: 0-100% • Strobe: 0-20Hz • Housing: Die Cast Aluminum Powder Coat Finish • Convection cooling which eliminates the use of fans and noise • Cooling: Convection (no fans) • Stylish design • Lens Plate: Tempered Glass • Lux (@ 2 meter): Red 1306, Green 2927, Blue 710, White 3117, RGB 7420 	
Max. ambient temperature t_a :	40°C; Max. housing temperature t_b : 80°C
Minimum distance:	
Minimum distance from flammable surfaces:	0,5m
Minimum distance to lighted object:	1m

Design and product specifications are subject to change without prior notice.



Website: www.Showtec.info
 Email: service@highlite.nl

Dimensions

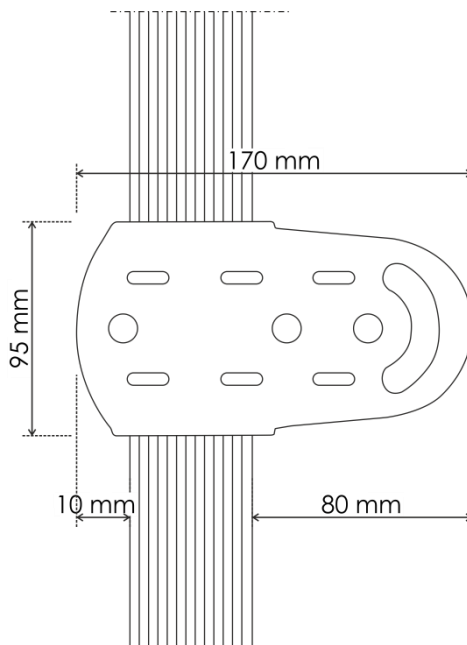
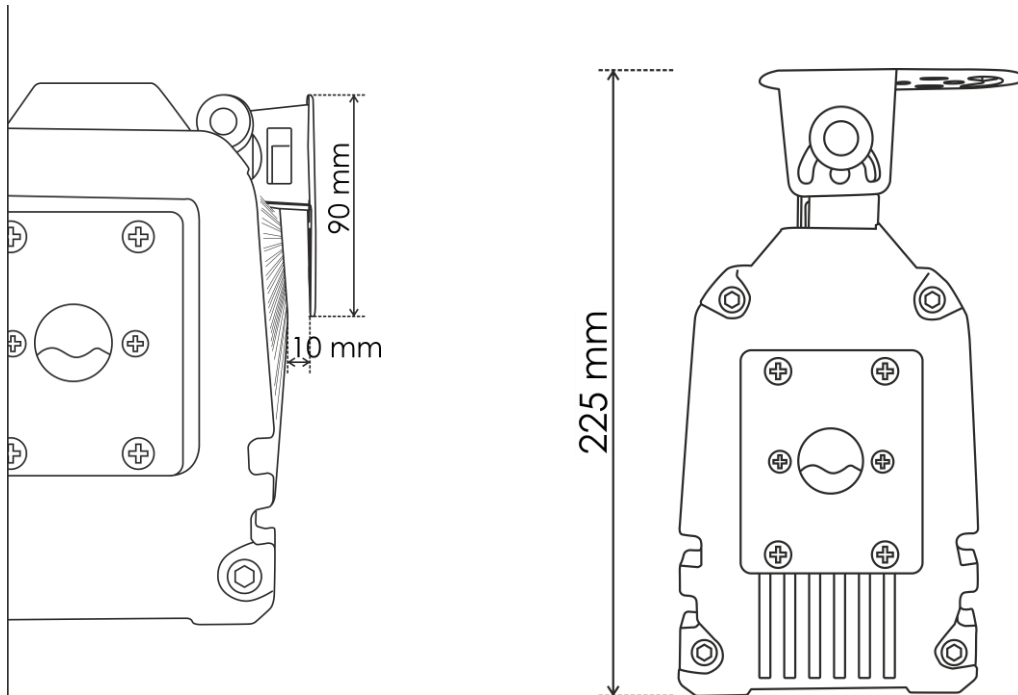
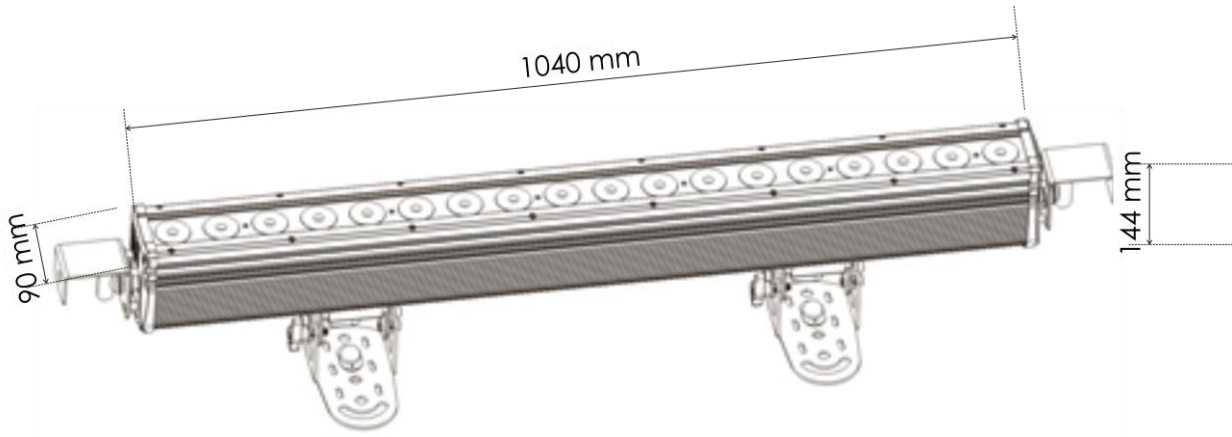



©2015 Showtec