

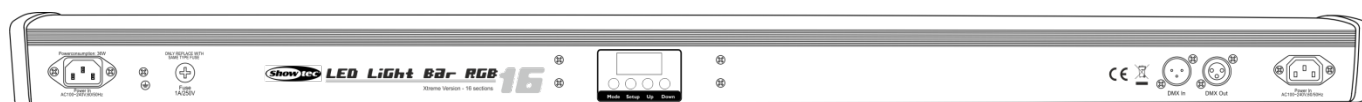

MANUAL



ENGLISH

LED Light Bar 16

V1

Ordercode: 42198

Table of contents

Warning	2
Unpacking Instructions.....	2
LED Expected Lifespan	2
Safety Instructions	2
Operating Determinations	4
Rigging	4
Connection with the mains.....	5
Return Procedure.....	6
Claims.....	6
Description of the device	7
Overview	7
Installation	7
Set Up and Operation	7
Control Modes.....	8
One LED Light Bar 16 (Built-in programs, Auto and Static Color Mode)	8
One LED Light Bar 16 (Sound-controlled).....	8
Multiple LED Light Bars (Master/Slave control).....	8
Multiple LED Light Bars (DMX Control).....	9
Fixture Linking.....	10
Data Cabling.....	10
Control Panel.....	11
Control Mode	11
DMX Addressing.....	11
Menu Overview.....	12
Main Menu Options.....	13
1. Built-in programs	13
2. Auto Mode.....	13
3. Sound-controlled Mode.....	13
4. Master/Slave Mode.....	13
5. DMX-512 Mode	14
6. Static Color Mode	14
7. Settings.....	14
DMX Channels.....	15
3 channels.....	15
5 channels.....	16
6 channels.....	16
12 channels.....	16
24 channels.....	17
48 channels.....	18
Maintenance	21
Replacing the Fuse.....	21
Troubleshooting	22
No Light.....	22
No Response to DMX.....	22
Product Specifications	24
Dimensions	25

Warning



**For your own safety, please read this user manual carefully
before your initial start-up!**



Unpacking Instructions

Immediately upon receiving this product, carefully unpack the carton and check the contents to ensure that all parts are present, and have been received in good condition. Notify the dealer immediately and retain packing material for inspection if any parts appear damaged from shipping or the carton itself shows signs of mishandling. Save the carton and all packing materials. In the event that a fixture must be returned to the factory, it is important that the fixture be returned in the original factory box and packing.

Your shipment includes:

- Showtec LED Light Bar 16
- IEC power cable (1,5 m)
- 2 brackets with 2 adjustment screws
- User manual

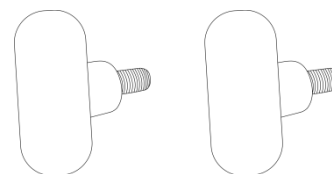

LED Expected Lifespan

LEDs gradually decline in brightness over time. HEAT is the dominant factor that leads to the acceleration of this decline. Packaged in clusters, LEDs exhibit higher operating temperatures than in ideal or singular optimum conditions. For this reason, when all color LEDs are used at their fullest intensity, life of the LEDs is significantly reduced. If improving the lifespan is of higher priority, place care in providing for lower operational temperatures. This may include climatic-environmental and the reduction of overall projection intensity.



CAUTION!

**Keep this device away from rain and moisture!
Unplug mains lead before opening the housing!**



Safety Instructions

Every person involved with the installation, operation and maintenance of this device has to:

- be qualified
- follow the instructions of this manual



**CAUTION! Be careful with your operations.
With a dangerous voltage you can suffer
a dangerous electric shock when touching the wires!**



Before the initial start-up, please make sure that there is no damage caused by transportation. Should there be any, consult your dealer and do not use the device.

To maintain perfect condition and to ensure a safe operation, it is absolutely necessary for the user to follow the safety instructions and warning notes contained in this manual.

Please consider that damages caused by manual modifications to the device are not subject to warranty.

This device contains no user-serviceable parts. Refer servicing to qualified technicians only.

IMPORTANT:

The manufacturer will not accept liability for any resulting damages caused by the non-observance of this manual or any unauthorized modification to the device.

- Never let the power cord come into contact with other cables! Handle the power cord and all connections with the mains with particular caution!
- Never remove warning or informative labels from the unit.
- Never use anything to cover the ground contact.
- Never lift the fixture holding it by the projector head, as the mechanics may be damaged. Always hold the fixture by the transport handles.
- Never place any material over the lens.
- Never look directly into the light source.
- Never leave any cables lying around.
- Never loosen the screws of the rotating gobo otherwise you risk opening of the ball bearing.
- Do not insert objects into air vents.
- Do not connect this device to a dimmerpack.
- Do not switch the device on and off in short intervals, as this will reduce the device's life.
- Do not touch the device's housing bare-handed during its operation (housing becomes very hot). Allow the fixture to cool for at least 5 minutes before handling.
- Do not shake the device. Avoid brute force when installing or operating the device.
- Only use the device indoors, avoid contact with water or other liquids.
- Only operate the fixture after having checked if the housing is firmly closed and all screws are tightly fastened.
- Only operate the device after having familiarized with its functions.
- Avoid flames and do not put close to flammable liquids or gases.
- Always keep the case closed while operating.
- Always allow a free air space of at least 50 cm around the unit for ventilation.
- Always disconnect power from the mains, when device is not used or before cleaning! Only handle the power cord holding it by the plug. Never pull out the plug by tugging the power cord.
- Make sure that the device is not exposed to extreme heat, moisture or dust.
- Make sure that the available voltage is not higher than stated on the rear panel.
- Make sure that the power cord is never crimped or damaged. Check the device and the power cord from time to time.
- If the lens is obviously damaged, it has to be replaced.
- If device was dropped or struck, disconnect mains power supply immediately. Have a qualified engineer inspect for safety before operating.
- If the device has been exposed to drastic temperature fluctuation (e.g. after transportation), do not switch it on immediately. The arising condensation water might damage your device. Leave the device switched off until it has reached room temperature.
- If your Showtec device fails to work properly, discontinue the use immediately. Pack the unit securely (preferably in the original packing material), and return it to your Showtec dealer for service.
- For adult use only.
- Never attempt to bypass the thermostatic switch or fuses.
- For replacement use fuses of same type and rating only.
- The user is responsible for correct positioning and operating of the LED Light Bar. The manufacturer will not accept liability for damages caused by the misuse or incorrect installation of this device.
- This device falls under protection class I. Therefore it is essential to connect the yellow/green conductor to earth.
- During the initial start-up some smoke or smell may arise. This is a normal process and does not necessarily mean that the device is defective.
- Repairs, servicing and electric connection must be carried out by a qualified technician.
- **WARRANTY:** Till one year after date of purchase.



**CAUTION! EYEDAMAGES !!!
NEVER LOOK DIRECTLY INTO THE LIGHTSOURCE !!!**



Operating Determinations

- This device is not designed for permanent operation. Consistent operation breaks will ensure that the device will serve you for a long time without defects.
- The minimum distance between light output and the illuminated surface must be bigger than 1 meter.
- The maximum ambient temperature $t_a = 40^\circ\text{C}$ must never be exceeded.
- The relative humidity must not exceed 50 % with an ambient temperature of 40°C .
- If this device is operated in any other way than the one described in this manual, the product may suffer damages and the warranty becomes void.
- Any other operation may lead to dangers like short-circuit, burns, electric shock, crash, etc.

You endanger your own safety and the safety of others!

Rigging

Please follow the European and national guidelines concerning rigging, trussing and all other safety issues.

Do not attempt the installation yourself !

Always let the installation be carried out by an authorized dealer !

Procedure:

- If the projector is lowered from the ceiling or high joists, professional trussing systems have to be used.
- Use a clamp to mount the projector, with the mounting bracket, to the trussing system.
- The projector must never be fixed swinging freely in the room.
- The installation must always be secured with a safety attachment, e.g. an appropriate safety net or safety cable.
- When rigging, derigging or servicing the projector, always make sure, that the area below the installation site is secured and that there are not any unauthorized people around.

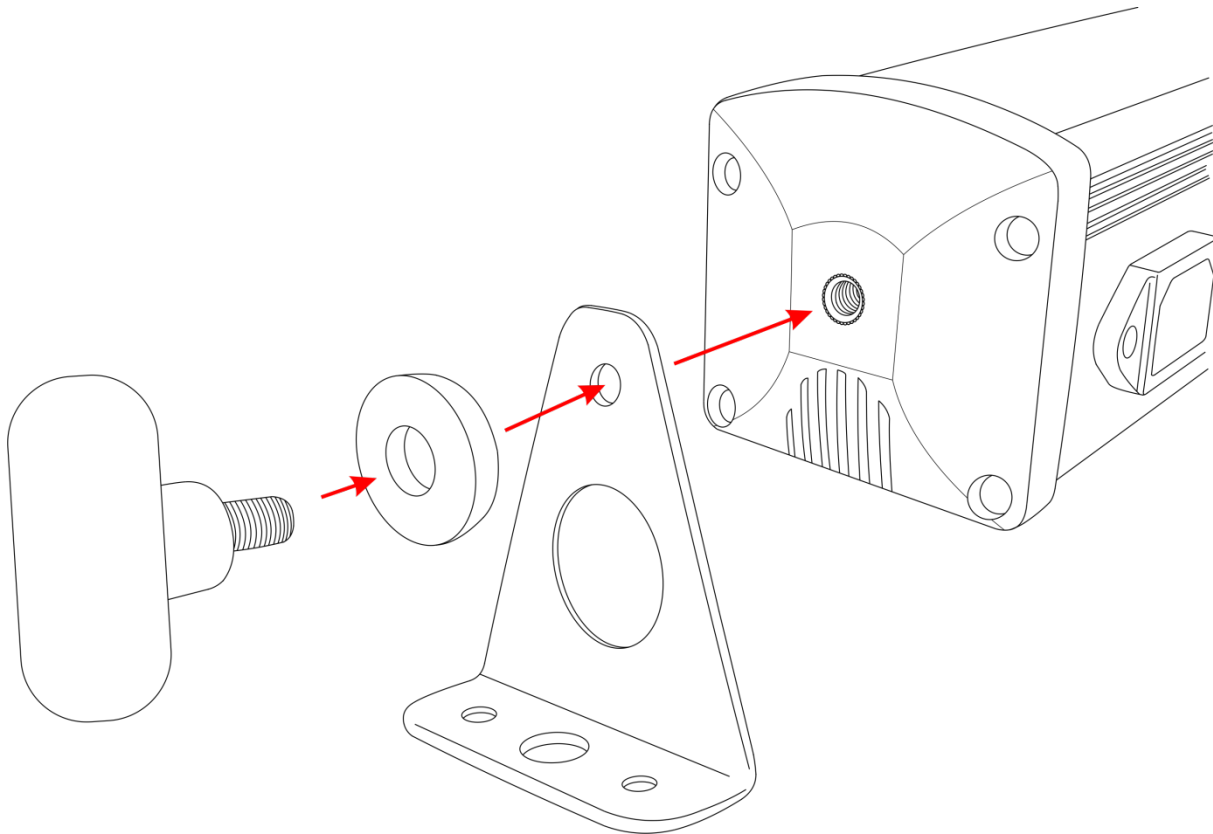
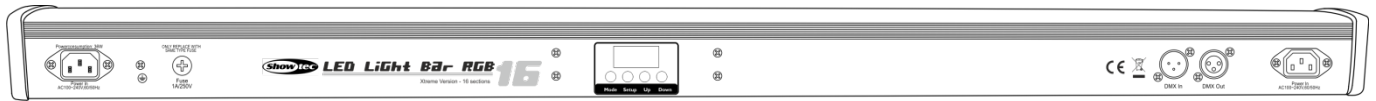

The LED Light Bar 16 can be placed on a flat stage floor or mounted to any kind of truss with the mounting brackets and adjustment screws.

Improper installation can cause serious injuries and/or damage of property!

Connection with the mains

Connect the device to the mains with the power-plug.
Always check if the right color cable is connected to the right place.

International	EU Cable	UK Cable	US Cable	Pin
L	BROWN	RED	YELLOW/COPPER	PHASE
N	BLUE	BLACK	SILVER	NEUTRAL
⊕	YELLOW/GREEN	GREEN	GREEN	PROTECTIVE GROUND

Make sure that the device is always properly connected to the earth!

Improper installation can cause serious injuries and/or damage of property!



Return Procedure

Returned merchandise must be sent prepaid and in the original packing, call tags will not be issued. Package must be clearly labeled with a Return Authorization Number (RMA number). Products returned without an RMA number will be refused. Highlite will not accept the returned goods or any responsibility. Call Highlite 0031-455667723 or mail aftersales@highlite.nl and request an RMA prior to shipping the fixture. Be prepared to provide the model number, serial number and a brief description of the cause for the return. Be sure to properly pack fixture, any shipping damage resulting from inadequate packaging is the customer's responsibility. Highlite reserves the right to use its own discretion to repair or replace product(s). As a suggestion, proper UPS packing or double-boxing is always a safe method to use.

Note: If you are given an RMA number, please include the following information on a piece of paper inside the box:

- 01) Your name
- 02) Your address
- 03) Your phone number
- 04) A brief description of the symptoms

Claims

The client has the obligation to check the delivered goods immediately upon delivery for any shortcomings and/or visible defects, or perform this check after our announcement that the goods are at their disposal. Damage incurred in shipping is the responsibility of the shipper; therefore the damage must be reported to the carrier upon receipt of merchandise.

It is the customer's responsibility to report and submit claims with the shipper in the event that a fixture is damaged due to shipping. Transportation damage has to be reported to us within one day after receipt of the delivery.

Any return shipment has to be made post-paid at all times. Return shipments must be accompanied with a letter defining the reason for return shipment. Non-prepaid return shipments will be refused, unless agreed otherwise in writing.

Complaints against us must be prepared in writing or sent by fax within 10 working days after receipt of the invoice. After this period complaints will not be handled anymore.

Complaints will only then be considered if the client has so far complied with all parts of the agreement, regardless of the agreement from which the obligation is resulting.

Description of the device

Features

The LED Light Bar 16 is a LED bar effect with high output and great effects.

- Input voltage: 100-240V, 60/50Hz
- Power consumption: 30W
- Light source: 240 x 10 mm RGB LED
- Output@2m: 613,3lux
- DMX channels: 3, 5, 6, 12, 24, 48
- Clear 4-digit LED display for easy setup
- Control modes: Built-in programs, Auto, Sound-controlled, Master/Slave, DMX-512 Mode, Static Color
- Control protocol: DMX-512
- 3-pin DMX signal connector IN/OUT
- Dimmer: 100%
- Strobe: 0-20Hz
- Beam Angle: 30°
- IP rating: IP20
- Housing: Metal & Flame retardant plastic
- Fuse: T1L/250V
- Dimensions: 1010 x 71 x 65 mm (LxWxH)
- Weight: 1,7 kg

Overview

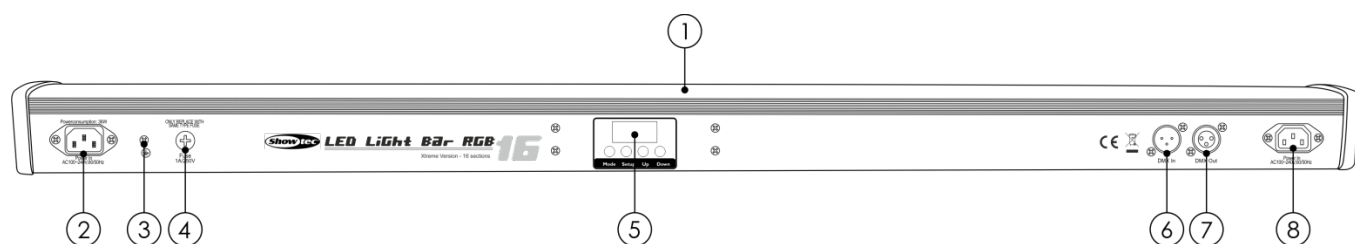

Fig. 01

- 01) 240 x 10 mm RGB LED
- 02) IEC power connector 100-240V IN
- 03) Ground/earth connection
- 04) Fuse T1L/250V
- 05) 4-digit LED display + control buttons
- 06) 3-pin DMX signal connector IN
- 07) 3-pin DMX signal connector OUT
- 08) IEC power connector 100-240V OUT

Installation

Remove all packing materials from the LED Light Bar 16. Check if all foam and plastic padding is removed. Connect all cables.

Do not supply power before the whole system is set up and connected properly.

Always disconnect from electric mains power supply before cleaning or servicing.

Damages caused by non-observance are not subject to warranty.

Set Up and Operation

Follow the directions below, as they pertain to your preferred operation mode.

Before plugging the unit in, always make sure that the power supply matches the product specification voltage. Do not attempt to operate a 120V specification product on 230V power, or vice versa.

Connect the device to the main power supply.

Control Modes

There are 6 modes:

- Built-in programs
- Auto Mode
- Static Color Mode
- Sound-controlled
- Master/Slave
- DMX-512 (3, 5, 6, 12, 24, 48CH)

One LED Light Bar (Built-in programs, Auto and Static Color Mode)

- 01) Fasten the effect light to a firm trussing. Leave at least 0,5 meter on all sides for air circulation.
- 02) Plug the end of the electric mains power cord into a proper electric power supply socket.
- 03) When the LED Light Bar is not connected with a DMX cable, it functions as a stand-alone device. Please see pages 13-14 for more information.

One LED Light Bar (Sound-controlled)

- 01) Fasten the effect light to a firm trussing. Leave at least 0,5 meter on all sides for air circulation.
- 02) Plug the end of the electric mains power cord into a proper electric power supply socket.
- 03) Turn on the music. If the device is set to sound-control, then the LED Light Bar 16 will react to the beat of the music. Please see page 13 for more information about the sound-control options.

Multiple LED Light Bars (Master/Slave control)

- 01) Fasten the effect light onto firm trussing. Leave at least 0,5 meter on all sides for air circulation.
- 02) Use a 3-pin XLR cable to connect the LED Light Bar 16.

The pins:



- 01) Earth
- 02) Signal -
- 03) Signal +

- 03) Link the units as shown in fig. 02. Connect the first unit's DMX "out" socket with the second unit's "in" socket, using a DMX-signal cable. Repeat this process to link the second, third, and fourth units. You can use the same functions on the master device as described on pages 13-14 (Built-in programs, Auto Mode, Static Color Mode or Sound-controlled Mode). This means that you can set your desired operation mode on the master device and all slave devices will react the same as the master device.

Multiple LED Light Bars (Master/Slave control)

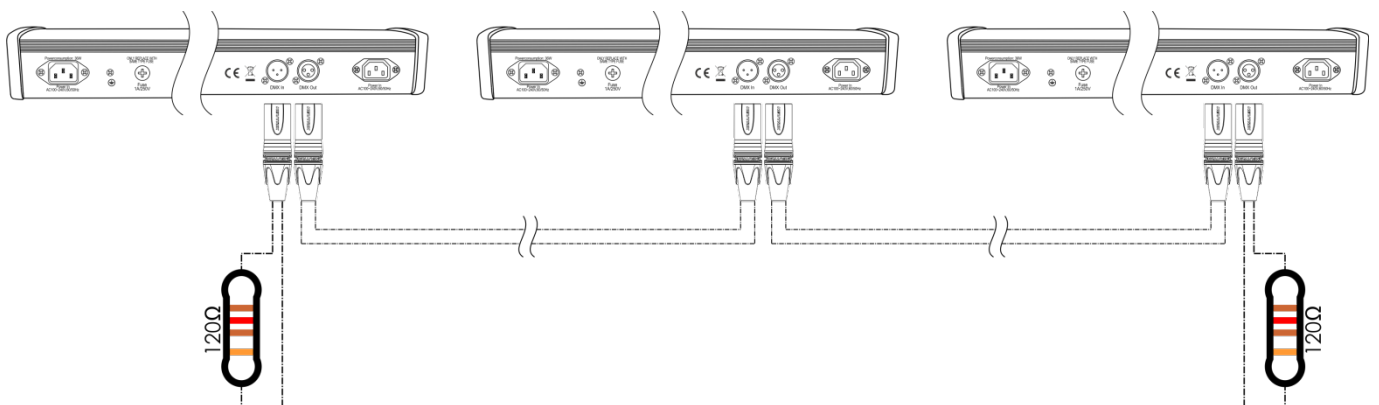
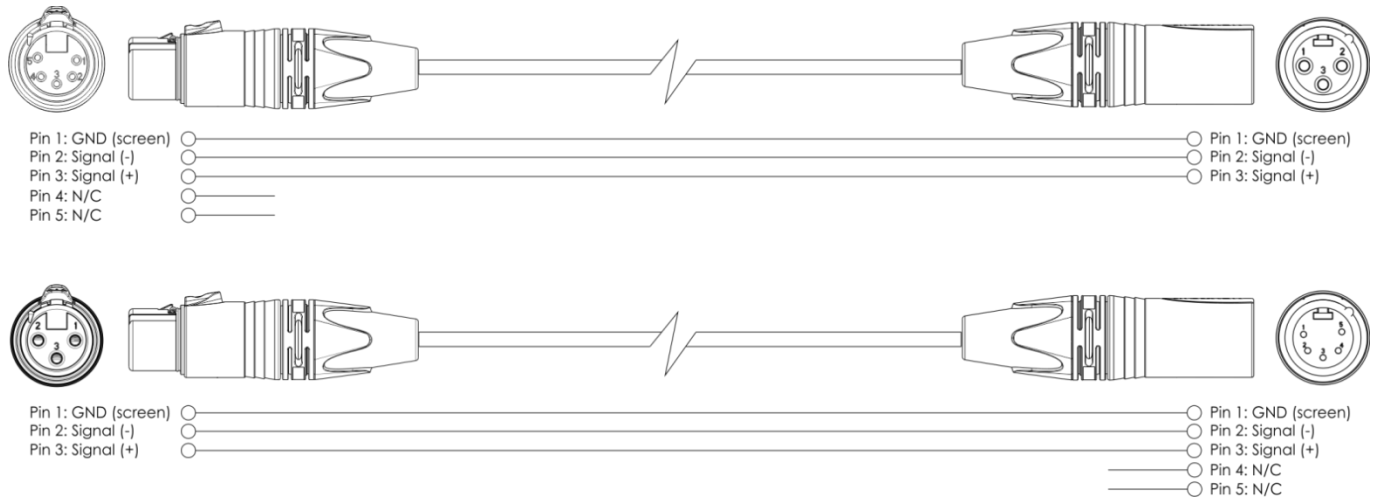

Fig. 02

Multiple LED Light Bars (DMX Control)

- 01) Fasten the effect light to a firm trussing. Leave at least 0,5 meter on all sides for air circulation.
- 02) Always use a safety cable (ordercode 70140 / 70141).
- 03) Use a 3-pin XLR cable to connect the LED Light Bar and other devices.



- 04) Link the units as shown in fig. 03. Connect the first unit's DMX "out" socket with the second unit's "in" socket, using a DMX-signal cable. Repeat this process to link the second, third, and fourth units.
- 05) Supply electric power: Plug electric mains power cords into each unit's IEC socket, then plug the other end of the mains power cord into proper electric power supply sockets, starting with the first unit. Do not supply power before the whole system is set up and connected properly.

Multiple LED Light Bars DMX Set Up

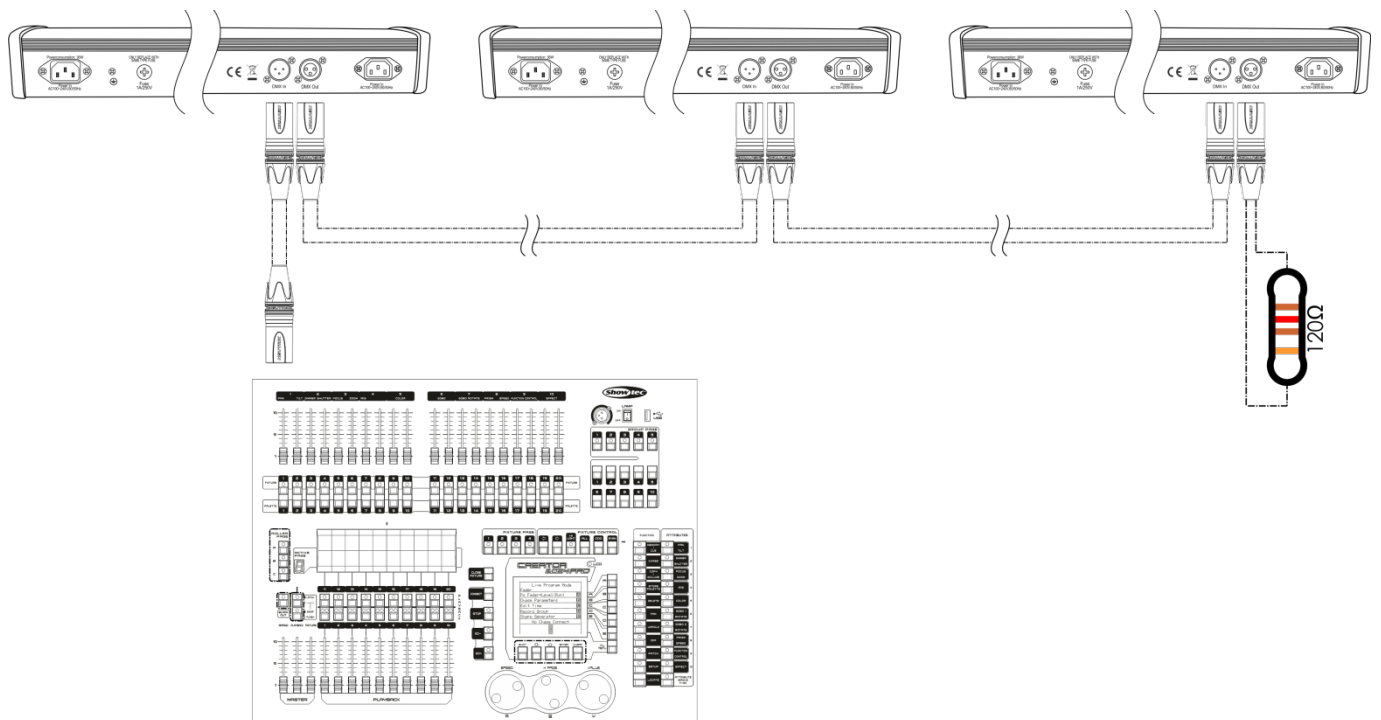

Fig. 03

Note : Link all cables before connecting electric power

Fixture Linking

You will need a serial data link to run light shows of one or more fixtures using a DMX-512 controller or to run synchronized shows of two or more fixtures set to a master/slave operating mode. The combined number of channels required by all the fixtures on a serial data link determines the number of fixtures the data link can support.

Important: Fixtures on a serial data link must be daisy-chained in a single line. To comply with the EIA-485 standard, no more than 30 devices should be connected on one data link. Connecting more than 30 fixtures on one serial data link without the use of a DMX optically isolated splitter may result in deterioration of the digital DMX signal.



Maximum recommended DMX data link distance: 100 meters

Maximum recommended number of fixtures on a DMX data link: 30 fixtures

Data Cabling

To link fixtures together, you must obtain data cables. You can purchase DAP Audio certified DMX cables directly from a dealer/distributor or construct your own cable. If you choose to create your own cable, please use data-grade cables that can carry a high quality signal and are less prone to electromagnetic interference.

DAP Audio Certified DMX Data Cables

- DAP Audio Basic microphone cable for allround use. bal. XLR/M 3 p. > XLR/F 3 p.
Ordercode: FL01150 (1,5m.), FL013 (3m.), FL016 (6m.), FL0110 (10m.), FL0115 (15m.), FL0120 (20m.).
- DAP Audio cable for the demanding user with exceptional audio-qualities and connector made by Neutrik®. **Ordercode:** FL71150 (1,5m.), FL713 (3m.), FL716 (6m.), FL7110 (10m.).

The LED Light Bar 16 can be operated with a controller in **control mode** or without the controller in **stand-alone mode**.

Control Panel

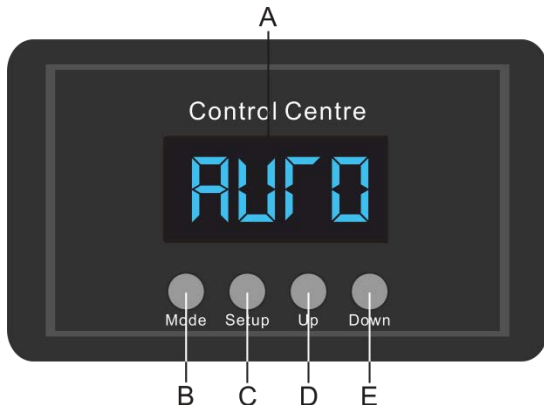

- A) LCD display
- B) MODE button
- C) SETUP button
- D) UP button
- E) DOWN button

Fig. 04

Control Mode

The fixtures are individually addressed on a data-link and connected to the controller. The fixtures respond to the DMX signal from the controller. (When you select the DMX address and save it, the controller will display the saved DMX address, next time.)

DMX Addressing

The control panel on the front side of the base allows you to assign DMX fixture addresses, which is the first channel with which the LED Light Bar will respond to the controller.

Please note, when you use the controller, the unit has **48** channels.

When using multiple LED Light Bars, make sure you set the DMX addresses right.

Therefore, the DMX address of the first LED Light Bar should be **1(001)**; the DMX address of the second LED Light Bar should be **1+48=49 (049)**; the DMX address of the third LED Light Bar should be **49+48=97 (097)**, etc.

Please, be sure that you do not have any overlapping channels in order to control each LED Light Bar correctly. If two or more LED Light Bars are addressed similarly, they will work similarly.

Controlling:

After having addressed all LED Light Bar fixtures, you may now start operating these via your lighting controller.

Note: After switching on, the LED Light Bar will automatically detect whether DMX 512 data is received or not. If there is no data received at the DMX-input, the "LED" on the control panel will not flash.

If not, the problem may be:

- The XLR cable from the controller is not connected with the input of the LED Light Bar 16.
- The controller is switched off or defective, the cable or connector is defective, or the signal wires are swapped in the input connector.

Note: It is necessary to insert an XLR termination plug (with 120 Ohm) in the last fixture in order to ensure proper transmission on the DMX data link.

Display Off after 20 seconds

When no button is pressed for 20 seconds, the display will turn off.







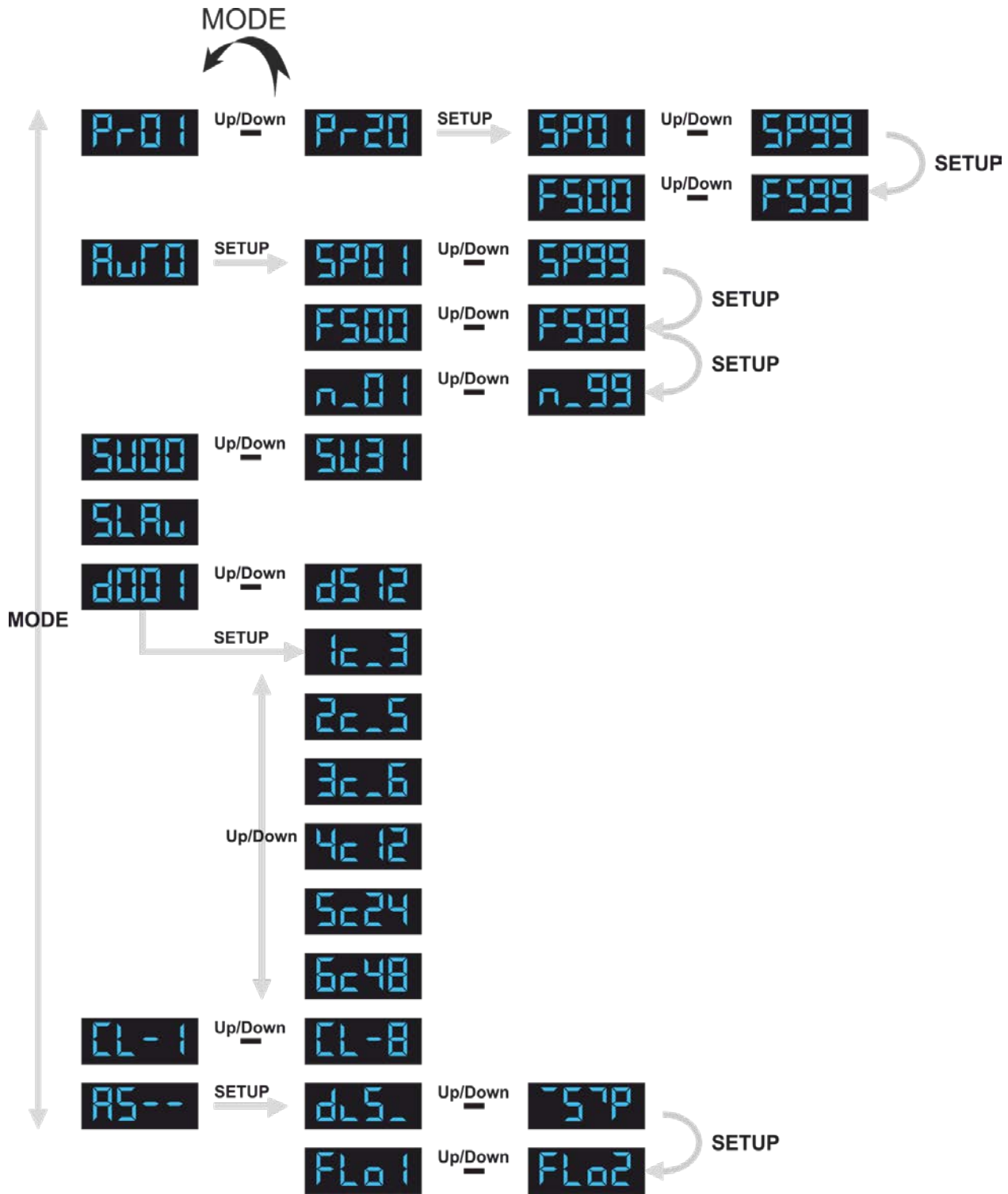



To light up the display, you have to press the MODE, SETUP, UP or DOWN button.

Once you have pressed the button, the display will light up.







Menu Overview









Main Menu Options

 Up/Down 	Built-in programs
	Auto Mode
 Up/Down 	Sound-controlled Mode
	Master/Slave Mode
 Up/Down 	DMX-512 Mode
 Up/Down 	Static Color Mode
	Settings



1. Built-in programs

- 01) While in the main menu, press the **MODE** button until the display shows one of the 20 built-in programs:  Up/Down .
- 02) Press the **SETUP** button to enter the menu.
- 03) Press the **SETUP** button to toggle between the following options:
 -  Up/Down  Program speed, 01-99 = from slow to fast.
 -  Up/Down  Strobe flash frequency, from low to high.
- 04) Press the **UP/DOWN** buttons to increase/decrease the values.
- 05) The device will now run the desired built-in program.

2. Auto Mode

- 01) While in the main menu, press the **MODE** button until the display shows .
- 02) Press the **SETUP** button to enter the menu.
- 03) Press the **SETUP** button to toggle between the following options:
 -  Up/Down  Program speed, 01-99 = from slow to fast.
 -  Up/Down  Strobe flash frequency, from low to high.
 -  Up/Down  Run time settings.
- 04) Press the **UP/DOWN** button to increase/decrease the values.
- 05) The device will now run all the built-in programs in a sequence.









3. Sound-controlled Mode

- 01) While in the main menu, press the **MODE** button until the display shows  Up/Down .
- 02) Press the **UP/DOWN** buttons to increase/decrease the sound sensitivity of the device. The adjustment range is between 00-31, from OFF to high sensitivity.
- 03) The device will now react to the beat of the background music.











4. Master/Slave Mode

- 01) While in the main menu, press the **MODE** button until the display shows .
- 02) Master/Slave Mode is now active and the device will react the same as the master device.





5. DMX-512 Mode

- 01) While in the main menu, press the **MODE** button until the display shows   .
- 02) Press the **UP/DOWN** buttons to set the desired DMX address between 001-512.
- 03) Press the **SETUP** button to enter the channel mode menu.
- 04) Press the **UP/DOWN** buttons to choose one of the following channel modes:
- | | |
|---|-----------------|
|  | 3-channel mode |
|  | 5-channel mode |
|  | 6-channel mode |
|  | 12-channel mode |
|  | 24-channel mode |
|  | 48-channel mode |

6. Static Color Mode

- 01) While in the main menu, press the **MODE** button until the display shows   .
- 02) Press the **UP/DOWN** buttons to choose one of the following static color presets:
- | | |
|---|--------------------|
|  | Red |
|  | Red + Green |
|  | Green |
|  | Green + Blue |
|  | Blue |
|  | Red + Blue |
|  | Red + Green + Blue |
|  | Blackout |

7. Settings

- 01) While in the main menu, press the **MODE** button until the display shows .
- 02) Press the **SETUP** button to enter the display settings.
- 03) Press the **UP/DOWN** buttons to choose the desired display view:
- | | |
|---|-----------------|
|  | Normal view |
|  | Horizontal flip |
- 04) Press the **SETUP** button to enter the program flow direction settings.
- 05) Press the **UP/DOWN** buttons to choose the desired program flow direction:
- | | |
|---|--------------------|
|  | From left to right |
|  | From right to left |

DMX Channels

3 channels

Channel 1 – Control Modes

0-9	Static Color Mode
10-19	Built-in program 1
20-29	Built-in program 2
30-39	Built-in program 3
40-49	Built-in program 4
50-59	Built-in program 5
60-69	Built-in program 6
70-79	Built-in program 7
80-89	Built-in program 8
90-99	Built-in program 9
100-109	Built-in program 10
110-119	Built-in program 11
120-129	Built-in program 12
130-139	Built-in program 13
140-149	Built-in program 14
150-159	Built-in program 15
160-169	Built-in program 16
170-179	Built-in program 17
180-189	Built-in program 18
190-199	Built-in program 19
200-209	Built-in program 20
210-255	Sound-controlled Mode

Channel 2 – Static Color Mode ⚠ CH1 must be set between 0-9 ⚠

0-5	Not functional
6-39	Red
40-79	Red + Green
80-119	Green
120-159	Green + Blue
160-199	Blue
200-239	Red + Blue
240-255	Red + Green + Blue

Channel 2 – Program speed ⚠ CH1 must be set between 10-209 ⚠

0-255	Program speed adjustment, from slow to fast
-------	---

Channel 2 – Sound sensitivity ⚠ CH1 must be set between 210-255 ⚠

0-255	Sound sensitivity adjustment, from low to high
-------	--

Channel 3 – Strobe effect ⚠ CH1 must be set between 0-209, CH2 must be open ⚠

0-255	Strobe flash frequency
-------	------------------------

5 channels

Channel 1 – Red intensity ⚠ Dimmer must be open ⚠

0-255 Gradual adjustment Red from 0 – 100%

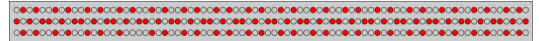

Channel 2 – Green intensity ⚠ Dimmer must be open ⚠

0-255 Gradual adjustment Green from 0 – 100%



Channel 3 – Blue intensity ⚠ Dimmer must be open ⚠

0-255 Gradual adjustment Blue from 0 – 100%



Channel 4 – Dimmer

0-255 Dimmer intensity, from dark to bright

Channel 5 – Strobe

0-2 Not functional

3-255 Strobe flash frequency, from low to high

6 channels

Channel 1 – Red 1 intensity

0-255 Gradual adjustment Red from 0 – 100%

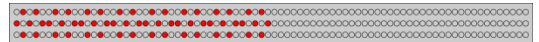

Channel 2 – Green 1 intensity

0-255 Gradual adjustment Green from 0 – 100%



Channel 3 – Blue 1 intensity

0-255 Gradual adjustment Blue from 0 – 100%

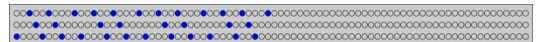

Channel 4 – Red 2 intensity

0-255 Gradual adjustment Red from 0 – 100%

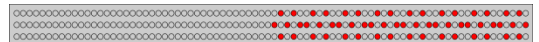

Channel 5 – Green 2 intensity

0-255 Gradual adjustment Green from 0 – 100%



Channel 6 – Blue 2 intensity

0-255 Gradual adjustment Blue from 0 – 100%



12 channels

Channel 1 – Red 1 intensity

0-255 Gradual adjustment Red from 0 – 100%



Channel 2 – Green 1 intensity

0-255 Gradual adjustment Green from 0 – 100%



Channel 3 – Blue 1 intensity

0-255 Gradual adjustment Blue from 0 – 100%



Channel 4 – Red 2 intensity

0-255 Gradual adjustment Red from 0 – 100%

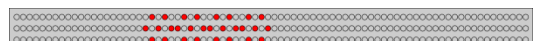

Channel 5 – Green 2 intensity

0-255 Gradual adjustment Green from 0 – 100%



Channel 12 – Blue 4 intensity

0-255 Gradual adjustment Blue from 0 – 100%

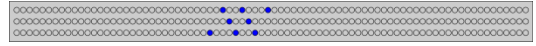

Channel 13 – Red 5 intensity

0-255 Gradual adjustment Red from 0 – 100%

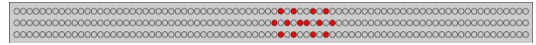

Channel 14 – Green 5 intensity

0-255 Gradual adjustment Green from 0 – 100%

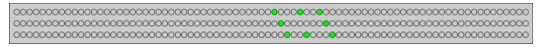

Channel 15 – Blue 5 intensity

0-255 Gradual adjustment Blue from 0 – 100%

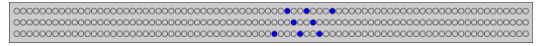

Channel 16 – Red 6 intensity

0-255 Gradual adjustment Red from 0 – 100%



Channel 17 – Green 6 intensity

0-255 Gradual adjustment Green from 0 – 100%



Channel 18 – Blue 6 intensity

0-255 Gradual adjustment Blue from 0 – 100%



Channel 19 – Red 7 intensity

0-255 Gradual adjustment Red from 0 – 100%

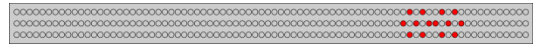

Channel 20 – Green 7 intensity

0-255 Gradual adjustment Green from 0 – 100%

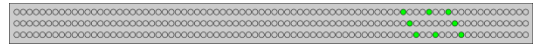

Channel 21 – Blue 7 intensity

0-255 Gradual adjustment Blue from 0 – 100%



Channel 22 – Red 8 intensity

0-255 Gradual adjustment Red from 0 – 100%

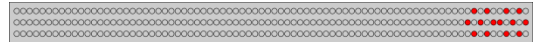

Channel 23 – Green 8 intensity

0-255 Gradual adjustment Green from 0 – 100%



Channel 24 – Blue 8 intensity

0-255 Gradual adjustment Blue from 0 – 100%



48 channels

Channel 1 – Red 1 intensity

0-255 Gradual adjustment Red from 0 – 100%



Channel 2 – Green 1 intensity

0-255 Gradual adjustment Green from 0 – 100%



Channel 3 – Blue 1 intensity

0-255 Gradual adjustment Blue from 0 – 100%

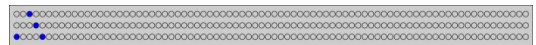

Channel 4 – Red 2 intensity















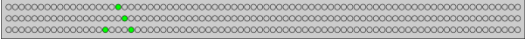

0-255 Gradual adjustment Red from 0 – 100%



Channel 5 – Green 2 intensity

0-255 Gradual adjustment Green from 0 – 100%

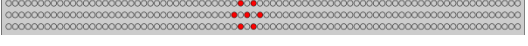

Channel 6 – Blue 2 intensity		
0-255	Gradual adjustment Blue from 0 – 100%	
Channel 7 – Red 3 intensity		
0-255	Gradual adjustment Red from 0 – 100%	
Channel 8 – Green 3 intensity		
0-255	Gradual adjustment Green from 0 – 100%	
Channel 9 – Blue 3 intensity		
0-255	Gradual adjustment Blue from 0 – 100%	
Channel 10 – Red 4 intensity		
0-255	Gradual adjustment Red from 0 – 100%	
Channel 11 – Green 4 intensity		
0-255	Gradual adjustment Green from 0 – 100%	
Channel 12 – Blue 4 intensity		
0-255	Gradual adjustment Blue from 0 – 100%	
Channel 13 – Red 5 intensity		
0-255	Gradual adjustment Red from 0 – 100%	
Channel 14 – Green 5 intensity		
0-255	Gradual adjustment Green from 0 – 100%	
Channel 15 – Blue 5 intensity		
0-255	Gradual adjustment Blue from 0 – 100%	
Channel 16 – Red 6 intensity		
0-255	Gradual adjustment Red from 0 – 100%	
Channel 17 – Green 6 intensity		
0-255	Gradual adjustment Green from 0 – 100%	
Channel 18 – Blue 6 intensity		
0-255	Gradual adjustment Blue from 0 – 100%	
Channel 19 – Red 7 intensity		
0-255	Gradual adjustment Red from 0 – 100%	
Channel 20 – Green 7 intensity		
0-255	Gradual adjustment Green from 0 – 100%	
Channel 21 – Blue 7 intensity		
0-255	Gradual adjustment Blue from 0 – 100%	
Channel 22 – Red 8 intensity		
0-255	Gradual adjustment Red from 0 – 100%	
Channel 23 – Green 8 intensity		
0-255	Gradual adjustment Green from 0 – 100%	
Channel 24 – Blue 8 intensity		
0-255	Gradual adjustment Blue from 0 – 100%	

Channel 25 – Red 9 intensity

0-255 Gradual adjustment Red from 0 – 100%

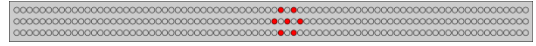

Channel 26 – Green 9 intensity

0-255 Gradual adjustment Green from 0 – 100%



Channel 27 – Blue 9 intensity

0-255 Gradual adjustment Blue from 0 – 100%

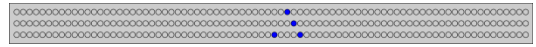

Channel 28 – Red 10 intensity

0-255 Gradual adjustment Red from 0 – 100%

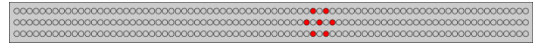

Channel 29 – Green 10 intensity

0-255 Gradual adjustment Green from 0 – 100%



Channel 30 – Blue 10 intensity

0-255 Gradual adjustment Blue from 0 – 100%



Channel 31 – Red 11 intensity

0-255 Gradual adjustment Red from 0 – 100%



Channel 32 – Green 11 intensity

0-255 Gradual adjustment Green from 0 – 100%

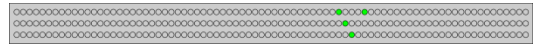

Channel 33 – Blue 11 intensity

0-255 Gradual adjustment Blue from 0 – 100%

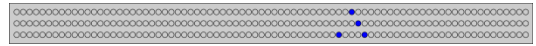

Channel 34 – Red 12 intensity

0-255 Gradual adjustment Red from 0 – 100%

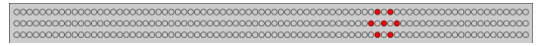

Channel 35 – Green 12 intensity

0-255 Gradual adjustment Green from 0 – 100%

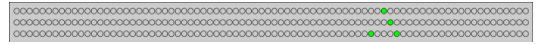

Channel 36 – Blue 12 intensity

0-255 Gradual adjustment Blue from 0 – 100%



Channel 37 – Red 13 intensity

0-255 Gradual adjustment Red from 0 – 100%



Channel 38 – Green 13 intensity

0-255 Gradual adjustment Green from 0 – 100%



Channel 39 – Blue 13 intensity

0-255 Gradual adjustment Blue from 0 – 100%



Channel 40 – Red 14 intensity

0-255 Gradual adjustment Red from 0 – 100%



Channel 41 – Green 14 intensity

0-255 Gradual adjustment Green from 0 – 100%

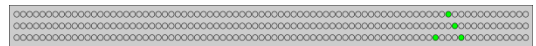

Channel 42 – Blue 14 intensity

0-255 Gradual adjustment Blue from 0 – 100%



Channel 43 – Red 15 intensity

0-255 Gradual adjustment Red from 0 – 100%



Channel 44 – Green 15 intensity

0-255 Gradual adjustment Green from 0 – 100%



Channel 45 – Blue 15 intensity

0-255 Gradual adjustment Blue from 0 – 100%



Channel 46 – Red 16 intensity

0-255 Gradual adjustment Red from 0 – 100%

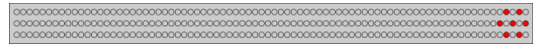

Channel 47 – Green 16 intensity

0-255 Gradual adjustment Green from 0 – 100%

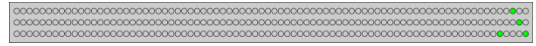

Channel 48 – Blue 16 intensity

0-255 Gradual adjustment Blue from 0 – 100%



Maintenance

The operator has to make sure that safety-related and machine-technical installations are to be inspected by an expert after every year in the course of an acceptance test.

The operator has to make sure that safety-related and machine-technical installations are to be inspected by a skilled person once a year.

The following points have to be considered during the inspection:

- 01) All screws used for installing the device or parts of the device have to be tightly connected and must not be corroded.
- 02) There may not be any deformations on housings, fixations and installation spots.
- 03) The electric power supply cables must not show any damages or material fatigue.

The LED Light Bar 16 requires almost no maintenance. However, you should keep the unit clean.

Otherwise, the fixture's light output will be significantly reduced. Disconnect the mains power supply, and then wipe the cover with a damp cloth. Do not immerse in liquid. Wipe lens clean with glass cleaner and a soft cloth. Do not use alcohol or solvents.

The front lens will require weekly cleaning, as smoke-fluid tends to build up residues, reducing the light-output very quickly.

Please clean internal components once a year with a light brush and vacuum cleaner.

Keep connections clean. Disconnect electric power, and then wipe the DMX and audio connections with a damp cloth. Make sure connections are thoroughly dry before linking equipment or supplying electric power.

Replacing the Fuse

Power surges, short-circuit or inappropriate electrical power supply may cause a fuse to burn out. If the fuse burns out, the product will not function whatsoever. If this happens, follow the directions below to do so.

- 01) Unplug the unit from electric power source.
- 02) Insert a screwdriver into the slot in the fuse cover. Turn the fuse holder counterclockwise. The fuse will come out.
- 03) Remove the used fuse. If brown or unclear, it is burned out.
- 04) Insert the replacement fuse into the holder where the old fuse was. Reinsert the fuse holder. Be sure to use a fuse of the same type and specification. See the product specification label for details.

Troubleshooting

This troubleshooting guide is meant to help solve simple problems.

If a problem occurs, carry out the steps below in sequence until a solution is found. Once the unit operates properly, do not carry out following steps.

No Light

If the light effect does not operate properly, refer servicing to a technician.

Response: Suspect three potential problem areas as: the power supply, the lamp, the fuse.

- 01) Power supply. Check that the unit is plugged into an appropriate power supply.
- 02) The LED. Return the LED Light Bar 16 to your Showtec dealer.
- 03) The fuse. Replace the fuse. See page 21 for replacing the fuse.
- 04) If all of the above appears to be O.K., plug the unit in again.
- 05) If you are unable to determine the cause of the problem, do not open the LED Light Bar 16, as this may damage the unit and the warranty will become void.
- 06) Return the device to your Showtec dealer.

No Response to DMX

Response: Suspect the DMX cable or connectors, a controller malfunction, a light effect DMX card malfunction.

- 01) Check the DMX setting. Make sure that DMX addresses are correct.
- 02) Check the DMX cable: Unplug the unit; change the DMX cable; then reconnect to electrical power. Try your DMX control again.
- 03) Determine whether the controller or light effect is at fault. Does the controller operate properly with other DMX products? If not, take the controller in for repair. If so, take the DMX cable and the light effect to a qualified technician.

Problem	Probable cause(s)	Remedy
One or more fixtures are completely dead.	No power to the fixture.	<ul style="list-style-type: none"> • Check that power is switched on and cables are plugged in.
	Primary fuse blown.	<ul style="list-style-type: none"> • Replace fuse.
Fixtures reset correctly, but all respond erratically or not at all to the controller.	The controller is not connected.	<ul style="list-style-type: none"> • Connect controller.
	3-pin XLR Out of the controller does not match XLR Out of the first fixture on the link (i.e. signal is reversed).	<ul style="list-style-type: none"> • Install a phase reversing cable between the controller and the first fixture on the link.
Fixtures reset correctly, but some respond erratically or not at all to the controller.	Poor data quality	<ul style="list-style-type: none"> • Check data quality. If much lower than 100 percent, the problem may be a bad data link connection, poor quality or broken cables, missing termination plug, or a defective fixture disturbing the link.
	Bad data link connection	<ul style="list-style-type: none"> • Inspect connections and cables. Correct poor connections. Repair or replace damaged cables.
	Data link not terminated with 120 Ohm termination plug.	<ul style="list-style-type: none"> • Insert termination plug in output jack of the last fixture on the link.
	Incorrect addressing of the fixtures.	<ul style="list-style-type: none"> • Check address setting.
	One of the fixtures is defective and disturbs data transmission on the link.	<ul style="list-style-type: none"> • Bypass one fixture at a time until normal operation is regained: unplug both connectors and connect them directly together. • Have the defective fixture serviced by a qualified technician.
	3-pin XLR Out on the fixtures does not match (pins 2 and 3 reversed).	<ul style="list-style-type: none"> • Install a phase-reversing cable between the fixtures or swap pin 2 and 3 in the fixture, that behaves erratically.
No light or lamp cuts out intermittently	Fixture is too hot.	<ul style="list-style-type: none"> • Allow fixture to cool. • Make sure air vents at control panel and front lens are not blocked. • Turn up the air conditioning .
	LEDs damaged	<ul style="list-style-type: none"> • Disconnect fixture and return to your dealer.
	The power supply settings do not match local AC voltage and frequency.	<ul style="list-style-type: none"> • Disconnect fixture. Check settings and correct if necessary.

Product Specifications

Model:	Showtec LED Light 16
Input Voltage:	100-240 VAC, 60/50Hz
Power consumption:	30W (full output)
DMX linking:	30pcs
Fuse:	T1L/250V
Dimensions:	1010 x 71 x 65 mm (LxWxH)
Weight:	1,7 kg
Operating and Programming:	
Signal pin OUT:	Pin 1 (earth), pin 2 (-), pin 3 (+)
DMX Mode:	3, 5, 6, 12, 24, 48 channels
Signal input:	3-pin XLR male
Signal output:	3-pin XLR female
Electro-mechanical effects:	
Light output@2m:	613,3 lux
Control modes:	Built-in programs, Auto, Sound-controlled, Master/Slave, DMX-512, Static Color
LED Quantity:	240 x 10 mm RGB LED
Color mixing:	RGB
Beam angle:	30°
Dimmer:	0-100%
Strobe:	0-20Hz
Housing:	Metal & Flame retardant plastic
DMX-control:	via standard DMX-controller
On Board:	4-digit LED display for easy setup
Connections:	IEC to Schuko & Data connector
Max. ambient temperature t_a :	40°C
Max. housing temperature t_B :	80°C
Minimum distance:	
Minimum distance from flammable surfaces:	0,5 m
Minimum distance to lighted object:	1 m

Design and product specifications are subject to change without prior notice.



Website: www.Showtec.info

Email: service@highlite.nl

Dimensions

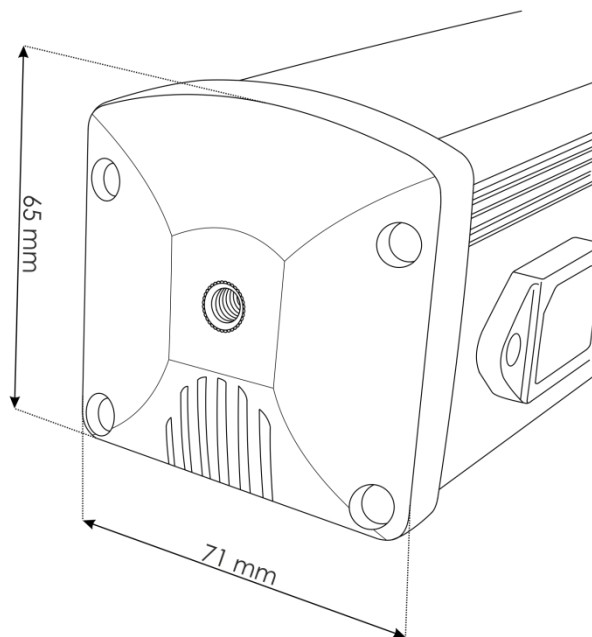
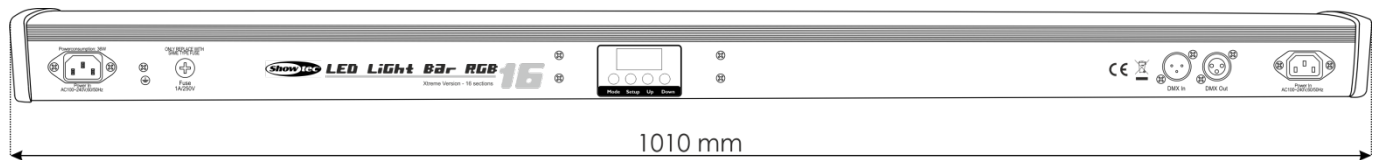



©2015 Showtec