

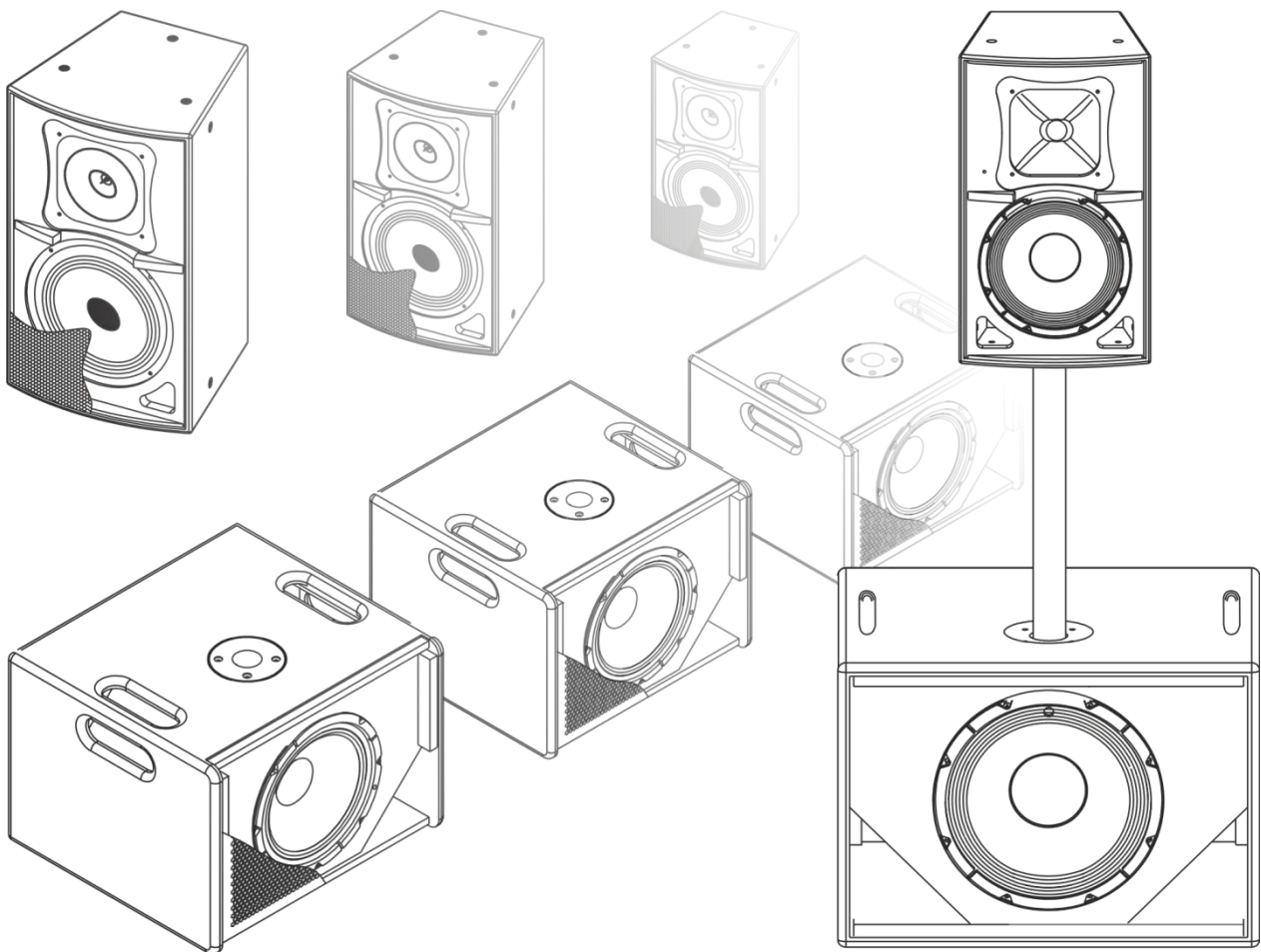

## MANUAL V2



ENGLISH

## DRX Active Series

Productcode:	D3634	D3635	D3636	D3637	D3640	D3641	D3642	D3647
Productname:	DRX-8A	DRX-10A	DRX-12A	DRX-15A	DRX-10BA	DRX-12BA	DRX-15BA	DRX-18BA

## Table of contents

---

<b>Warning</b> .....	2
Unpacking Instructions.....	2
Safety Instructions .....	2
Connection with the mains.....	4
Return Procedure.....	4
Claims.....	4
<b>Features</b> .....	5
<b>Accessories</b> .....	5
<b>Rear Panel Description</b> .....	6
DRX-10BA/12BA/15BA/18BA SUB.....	6
DRX-8A/10A/12A/15A .....	7
<b>Connection Examples</b> .....	8
Two Active Subwoofers & Two Active Satellite Speakers.....	8
One Active Subwoofer & Two Active Satellite Speakers .....	9
Two Active Satellite Speakers .....	10
<b>Frequency Response Diagram</b> .....	11
DRX-10BA/12BA/15BA/18BA.....	11
DRX-8A/10A/12A/15A .....	12
<b>Connection Cables</b> .....	13
<b>Technical Specifications</b> .....	14
DRX-10BA Sub .....	14
DRX-12BA Sub .....	14
DRX-15BA Sub .....	15
DRX-18BA Sub .....	15
DRX-8A .....	16
DRX-10A .....	16
DRX-12A .....	17
DRX-15A .....	17
<b>Troubleshooting</b> .....	18
<b>Notes</b> .....	19

## Warning



**FOR YOUR OWN SAFETY, PLEASE READ THIS USER MANUAL CAREFULLY  
BEFORE YOUR INITIAL START-UP!**



## Unpacking Instructions

Immediately upon receiving this product, carefully unpack the carton and check the contents to ensure that all parts are present, and have been received in good condition. Notify the dealer immediately and retain packing material for inspection if any parts appear damaged from shipping or the carton itself shows signs of mishandling. Save the carton and all packing materials. In the event that a fixture must be returned to the factory, it is important that the fixture be returned in the original factory box and packing.

## Safety Instructions

Every person involved with the installation, operation and maintenance of this device have to:

- be qualified
- follow the instructions of this manual



**CAUTION! Be careful with your operations.  
With a dangerous voltage you can suffer  
a dangerous electric shock when touching the wires!**



Before your initial start-up, please make sure that there is no damage caused by transportation. Should there be any, consult your dealer and do not use the device.

To maintain perfect condition and to ensure a safe operation, it is absolutely necessary for the user to follow the safety instructions and warning notes written in this manual.

Please consider that damages caused by manual modifications to the device are not subject to warranty. This device contains no user-serviceable parts. Refer servicing to qualified technicians only.

## IMPORTANT!

The manufacturer will not accept liability for any resulting damages caused by the non-observance of this manual or any unauthorized modification to the system.

- Always disconnect power from the mains, when system is not used. Only handle the power-cord by the plug. Never pull out the plug by tugging the power-cord.
- Always operate the unit with the AC ground wire connected to the electrical system ground.
- Avoid flames and do not put close to flammable liquids or gases.
- Avoid ground loops! Always be sure to connect the power amps and the mixing console to the same electrical circuit to ensure the same phase!
- Avoid installing your equipment very near radio or TV sets, mobile phones, etc., as these can cause RF (radio frequency) interference.
- Before changing your grounds around, always turn your amplifiers down.
- Before connecting or disconnecting the power cord, make certain the ON / OFF switch is in the OFF position.
- Before switching on or off make certain the sound system's amplifiers are off or turned down: this will avoid signal peaks, which are annoying and sometimes dangerous (particularly for speaker enclosures).
- Do not connect (parallel or series) an amplifier output with any other amplifier output.
- Do not connect this device to a dimmer pack.
- Do not drive the inputs with a signal level bigger, than required to drive the equipment to full output.
- Do not insert objects into air vents.

- Do not open this device. Risk: hazardous radiation exposure.
- Do not run the output of any amplifier channel, back into another channel's input.
- Do not switch the system on and off in short intervals, as this would reduce the system's life.
- Extreme frequency boosts in connection with a high input signal level may lead to overdriving your equipment. Should this occur, it is necessary to reduce the input signal level by using the INPUT control.
- For replacement use fuses of same type and rating only.
- If device is dropped or struck, disconnect mains power supply immediately. Have a qualified engineer inspect for safety before operating.
- If the system has been exposed to drastic temperature fluctuation (e.g. after transportation), do not switch it on immediately. The arising condensation water might damage your system. Leave the system switched off until it has reached room temperature.
- In system setup, the amplifier's output power must be 50%-100% more than the loaded loudspeakers rated power.
- Keep this user's manual for future consultation. Also remember that the crossover will get a better price on the secondhand market if (as well as being in good condition) it has its original documentation and packaging.
- Make sure that the available voltage is not higher than stated on the rear panel.
- Make sure that the power-cord is never crimped or damaged. Check the device and the power-cord from time to time.
- Make sure that the signals into the mixer are balanced, otherwise hum could be created.
- Make sure that there is sufficient room on all sides of the system for air circulation.
- Make sure you don't use the wrong kind of cables or defective cables.
- Make sure you use DI boxes to balance unbalanced signals; All incoming signals should be clear
- Never let the power-cord come into contact with other cables! Handle the power-cord and all connections with the mains with particular caution!
- Never remove warning or informative labels from the unit.
- Never use anything to cover the ground contact.
- Only use device indoor, avoid contact with water or other liquids.
- Please turn off the power switch, when changing the power cord or signal cable, or select the input mode switch.
- Prevent distortion! Make sure that all components connected to the DRX-Series have sufficient power ratings. Otherwise distortion will be generated because the components are operated at their limits.
- Repairs, servicing and electric connection must be carried out by a qualified technician.
- Sometimes, when you want to send one signal to more than one amplifier, you should use a signal distributor.
- The best way (even if not always feasible) to avoid ground loops is to connect the electric ground of all the equipment to a single central point ("star" system). In this case, the central point can be the mixer.
- To avoid or solve hum and buzzing troubles, try different combinations of lifting grounds on units that are supplied with ground lift switches or make sure all chassis are connected to earth ground, either through the A.C. power cord ground or by the front panel rack mount screws.
- To emphasize a frequency range, you don't necessarily have to move its respective sliding control upward; try lowering surrounding frequency ranges instead. This way, you avoid causing the next piece of equipment in your sound path to overdrive. You also preserve valuable dynamic reserve ("headroom")
- WARRANTY: Till one year after date of purchase.
- When connecting the other parts of your sound system, watch out for the so-called "ground loops".

**Connection with the mains**

Connect the device to the mains with the power-plug.

Always pay attention, that the right color cable is connected to the right place.

International	EU Cable	UK Cable	US Cable	Pin
L	BROWN	RED	YELLOW/COPPER	FASE
N	BLUE	BLACK	SILVER	NUL
	YELLOW/GREEN	GREEN	GREEN	EARTH

Make sure that the device is always connected properly to the earth!

**Improper installation can cause serious damage to people and property!**



**Return Procedure**



Returned merchandise must be sent prepaid and in the original packing, call tags will not be issued. Package must be clearly labeled with a Return Authorization Number (RMA number). Products returned without an RMA number will be refused. Highlite will not accept the returned goods or any responsibility. Call Highlite 0031-455667723 or mail [aftersales@highlite.nl](mailto:aftersales@highlite.nl) and request an RMA prior to shipping the fixture. Be prepared to provide the model number, serial number and a brief description of the cause for the return. Be sure to properly pack fixture, any shipping damage resulting from inadequate packaging is the customer's responsibility. Highlite reserves the right to use its own discretion to repair or replace product(s). As a suggestion, proper UPS packing or double-boxing is always a safe method to use.

**Note: If you are given an RMA number, please include the following information on a piece of paper inside the box:**

- 1) Your name
- 2) Your address
- 3) Your phone number
- 4) A brief description of the symptoms

**Claims**

The client has the obligation to check the delivered goods immediately upon delivery for any short-comings and/or visible defects, or perform this check after our announcement that the goods are at their disposal. Damage incurred in shipping is the responsibility of the shipper; therefore the damage must be reported to the carrier upon receipt of merchandise.

It is the customer's responsibility to notify and submit claims with the shipper in the event that a fixture is damaged due to shipping. Transportation damage has to be reported to us within one day after receipt of the delivery.

Any return shipment has to be made post-paid at all times. Return shipments must be accompanied with a letter defining the reason for return shipment. Non-prepaid return shipments will be refused, unless otherwise agreed in writing.

Complaints against us must be made known in writing or by fax within 10 working days after receipt of the invoice. After this period complaints will not be handled anymore.

Complaints will only then be considered if the client has so far complied with all parts of the agreement, regardless of the agreement of which the obligation is resulting.

## Features

---

These series products include active speaker cabinets and subwoofer.

### ACTIVE SPEAKERS:

1. DRX-8A
2. DRX-10A
3. DRX-12A
4. DRX-15A

### SUBWOOFER:

1. DRX-10BA
2. DRX-12BA
3. DRX-15BA
4. DRX-18BA

These products are design to provide a cost effective high grade solution, and they can be used for all kinds of applications, such as churches, conference center, disco, etc. You can select right model according to your request.

## Accessories

---

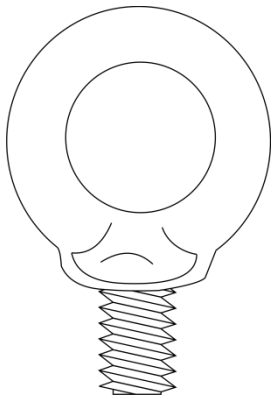

Speaker hanging eye  
Ø 8mm

Ordercode: D8435



Distance stand  
Ø 35mm

Ordercode: D8450

## Rear Panel Description

### DRX-10BA/12BA/15BA/18BA SUB

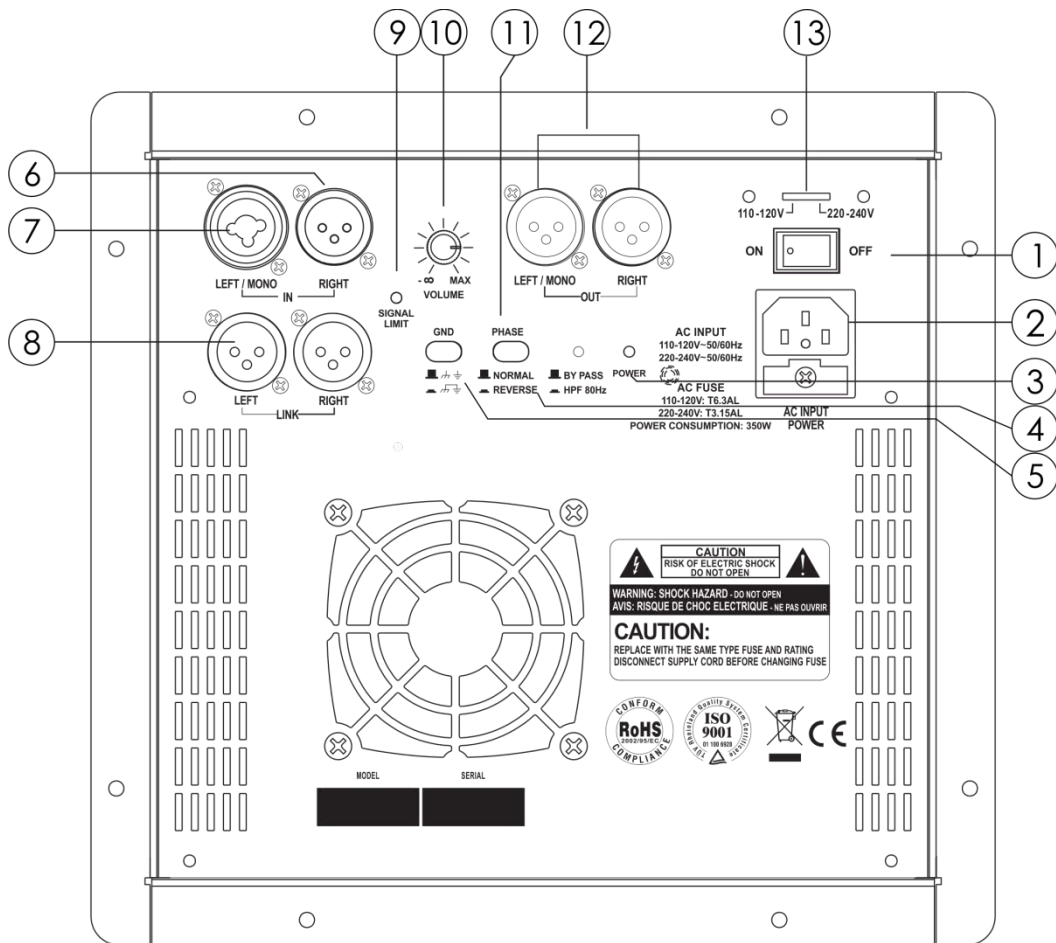

- |   |  |
|---|--|
| ① ON-OFF main power switch                        | ⑧ LINK LEFT/RIGHT ON XLR CONNECTOR             |
| ② Input AC power socket with main fuse            | ⑨ SIGNAL/LIMIT, Red LED, indicate ON status    |
| ③ POWER, Green LED, indicate ON status            | ⑩ VOLUME main power amplifier control          |
| ④ BYPASS Switch Select High pass filter or bypass | ⑪ PHASE Switch Reverse the Polarity of SUB OUT |
| ⑤ Ground Lift Switch                              | ⑫ OUT LEFT/RIGHT ON 2x XLR CONNECTOR           |
| ⑥ LINE IN RIGHT ON XLR CONNECTOR                  | ⑬ POWER SWITCH SELECTOR                        |
| ⑦ LINE IN LEFT/MONO ON COMBO CONNECTOR            |  |

DRX-8A/10A/12A/15A

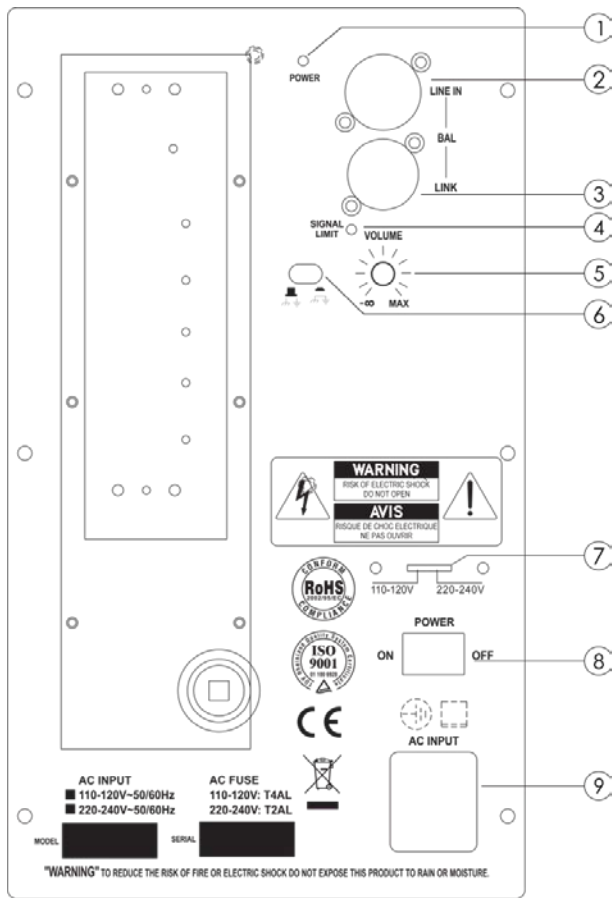

DRX-8A

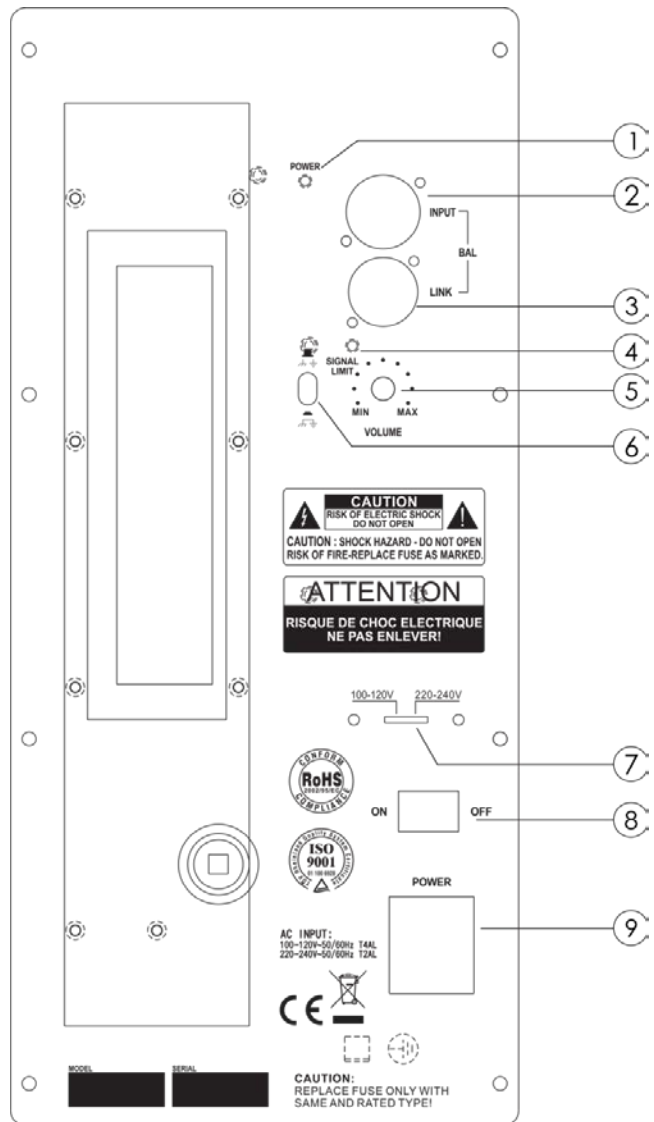

DRX-10A/12A/15A

- ① POWER LED INDICATOR
- ② MIC IN with balanced XLR & TRS for Microphone
- ③ LINE OUT at 0dB on XLR & TRS connector
- ④ Signal Limit LED
- ⑤ Volume Control

- ⑥ GND Switch
- ⑦ AC Input Voltage Selector
- ⑧ Main Power Switch
- ⑨ AC Power Inlet with AC Fuse



## Connection Examples

### Two Active Subwoofers & Two Active Satellite Speakers

- 1) Make your initial connections with all the equipment powered off and ensure that all the main volume controls are turned completely.
- 2) Connect one side of the signal cable at your audio mixer into OUTPUT LEFT/RIGHT and the other side of the cable into the LINE INPUT of your active subwoofers.
- 3) Connect one side of another signal cable at your active subwoofers into LINK LEFT/RIGHT or OUT LEFT/RIGHT and the other side of the cable into the LINE INPUT LEFT/RIGHT of your active satellite speakers.
- \* If you connect into the OUT LEFT/RIGHT and press the BYPASS switch, the 80Hz HPF will be activated.
- 4) Connect the power cords to main.
- 5) Turn on your mixer first, then the active speaker cabinets.
- 6) Turn up the volume controls of the active speaker cabinets.
- 7) Use PFL function to get the proper input level for the mixer and adjust the Main Mix Level.
- 8) After using your equipment, turn off your active speaker cabinets first, then the mixer.

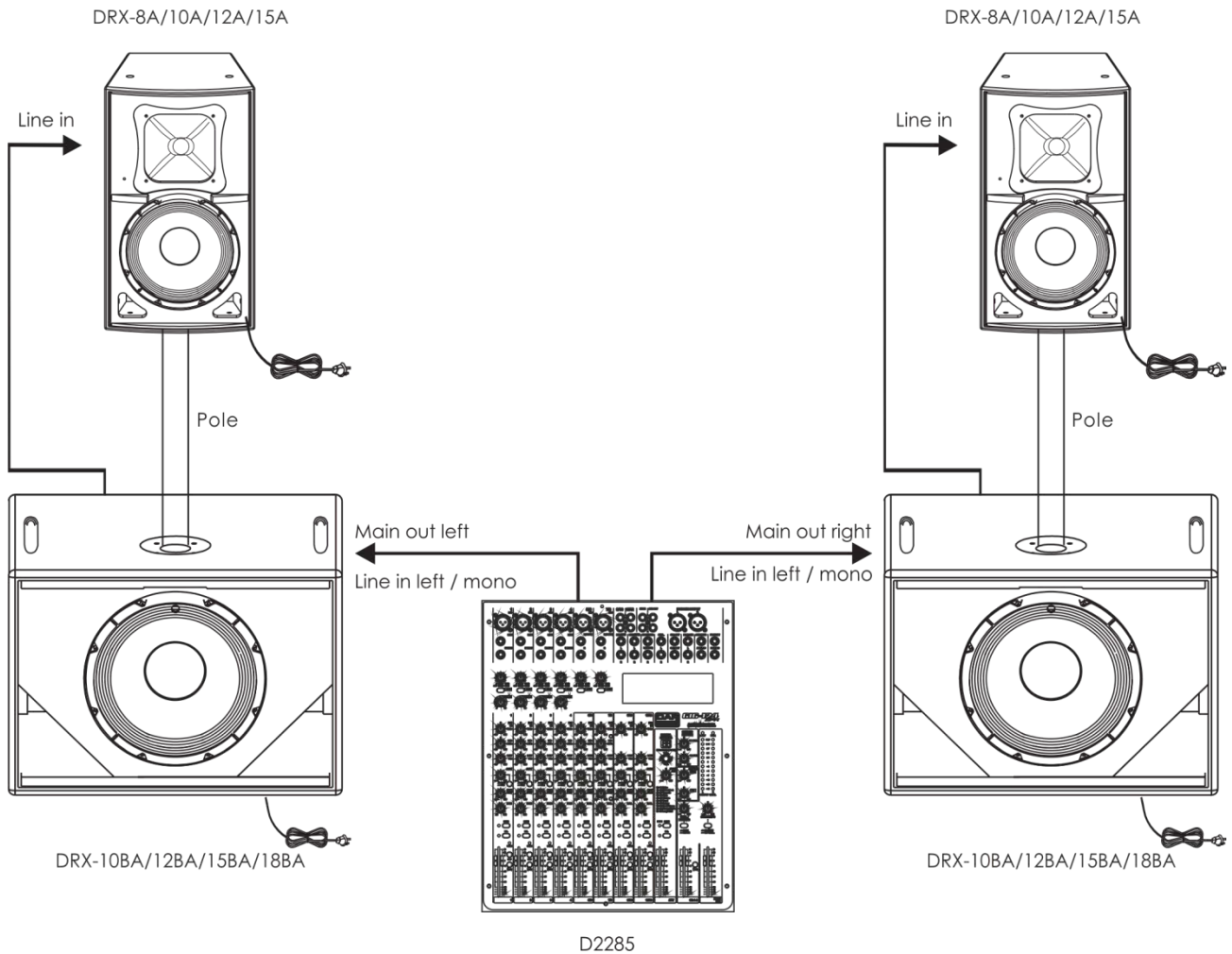

## One Active Subwoofer & Two Active Satellite Speakers

- 1) Make your initial connections with all the equipment powered off and ensure that all the main volume controls are turned completely.
- 2) Connect one side of the signal cable at your audio mixer into OUTPUT LEFT/RIGHT and the other side of the cable into the LINE INPUT LEFT/RIGHT of your active subwoofer.
- 3) Connect one side of another signal cable at your active subwoofer into LINK LEFT/RIGHT or OUT LEFT/RIGHT and the other side of the cable into the LINE INPUT LEFT/RIGHT of your active satellite speakers.
- \* If you connect into the OUT LEFT/RIGHT and press the BYPASS switch, the 80Hz HPF will be activated.
- 4) Connect the power cords to main.
- 5) Turn on your mixer first, then the active speaker cabinets.
- 6) Turn up the volume controls of the active speaker cabinets.
- 7) Use PFL function to get the proper input level for the mixer and adjust the Main Mix Level.
- 8) After using your equipment, turn off your active speaker cabinets first, then the mixer.

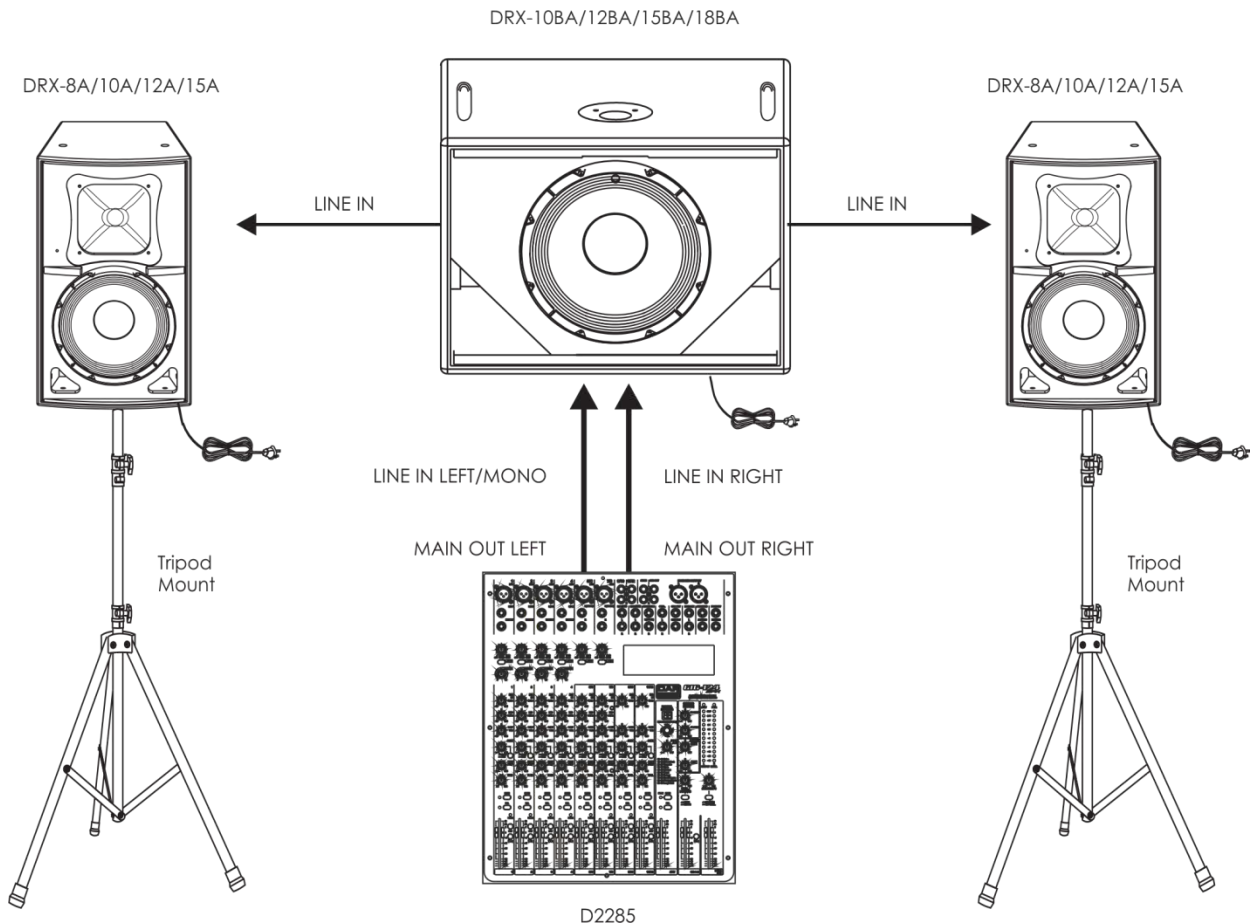

## Two Active Satellite Speakers

- 1) Make your initial connections with all the equipment powered off and ensure that all the main volume controls are turned completely.
- 2) Connect one side of the signal cable at your audio mixer into OUTPUT LEFT/RIGHT and the other side of the cable into the LINE INPUT LEFT/RIGHT of your active satellite speakers.
- 3) Connect the power cords to main.
- 4) Turn on your mixer first, then the active speaker cabinets.
- 5) Turn up the volume controls of the active speaker cabinets.
- 6) Use PFL function to get the proper input level for the mixer and adjust the Main Mix Level.
- 7) After using your equipment, turn off your active speaker cabinets first, then the mixer.

DRX-8A/10A/12A/15A

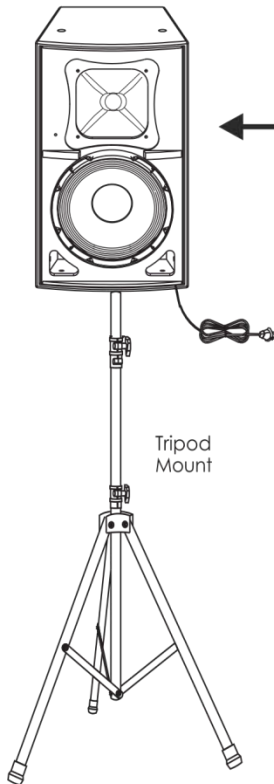

Tripod Mount

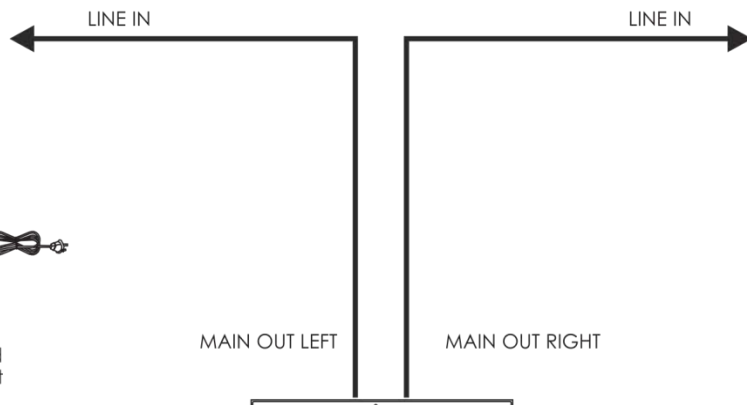

MAIN OUT LEFT

MAIN OUT RIGHT

DRX-8A/10A/12A/15A

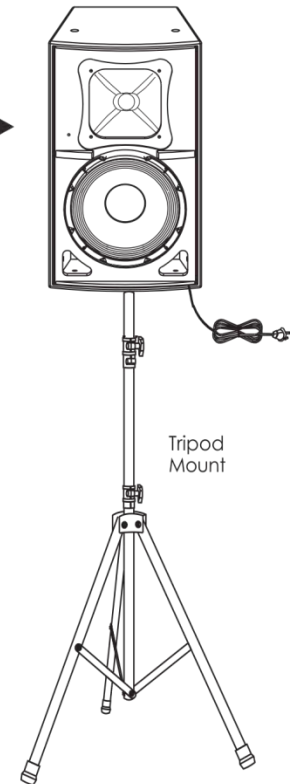

Tripod Mount

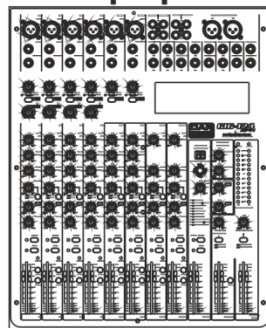

D2285

# Frequency Response Diagram

## DRX-10BA/12BA/15BA/18BA

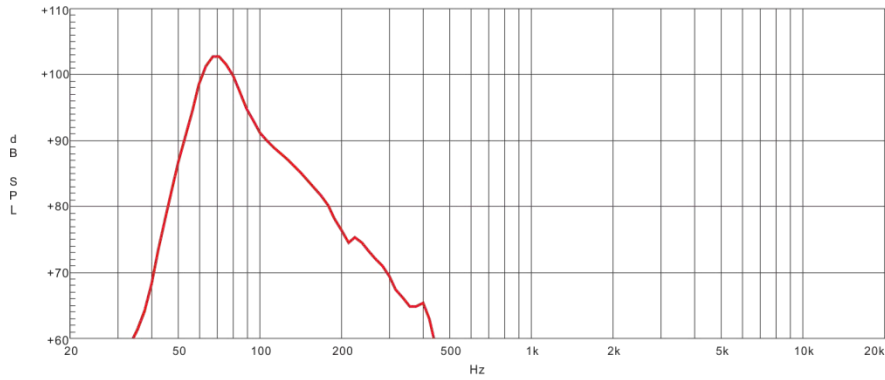

DRX-10BA

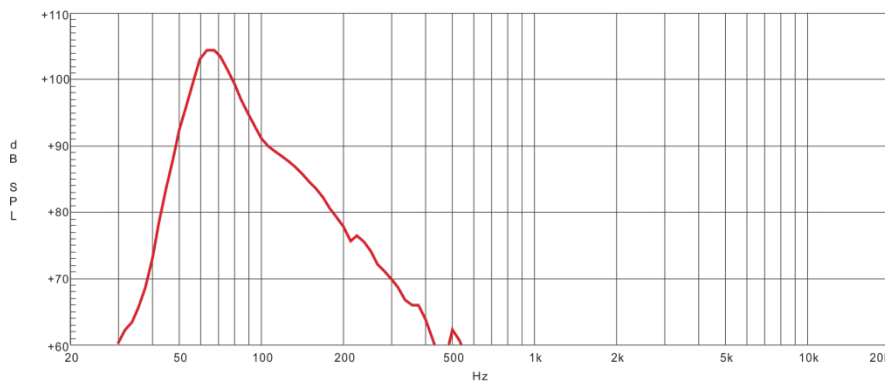

DRX-12BA

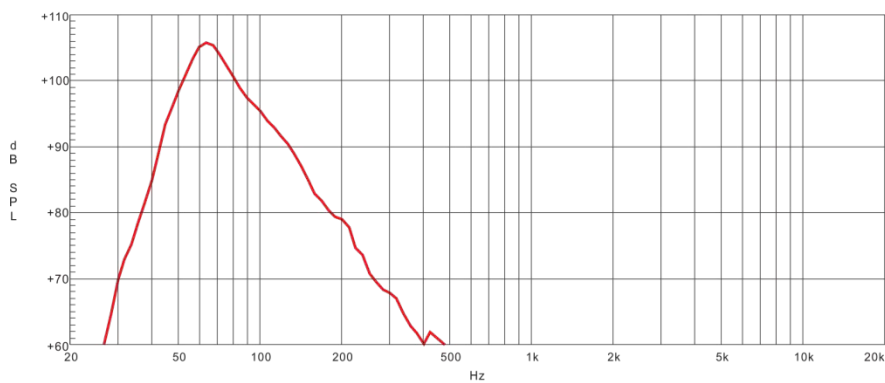

DRX-15BA

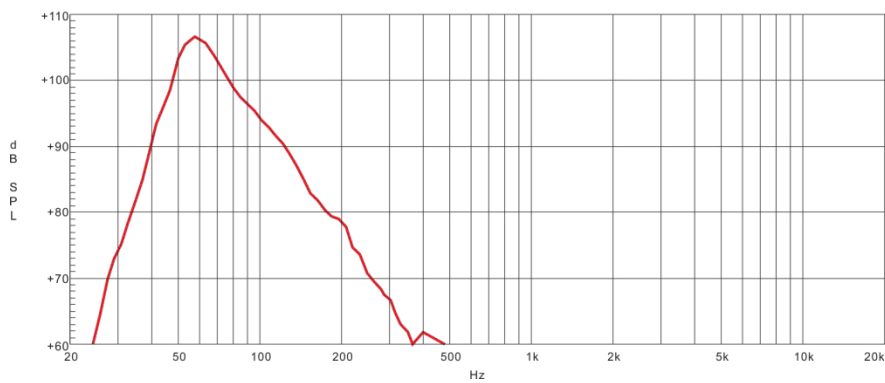

DRX-18BA

DRX-8A/10A/12A/15A

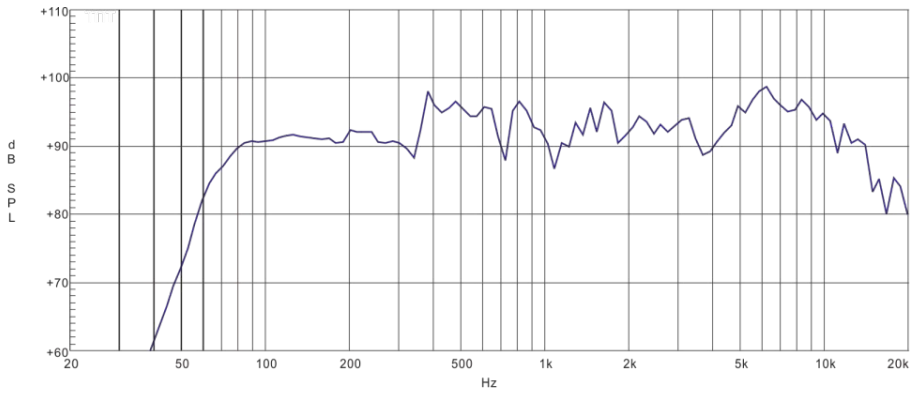

DRX-8A

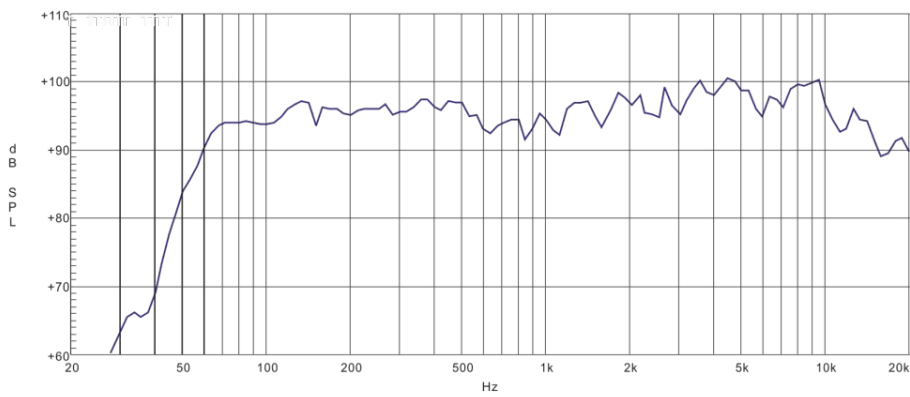

DRX-10A

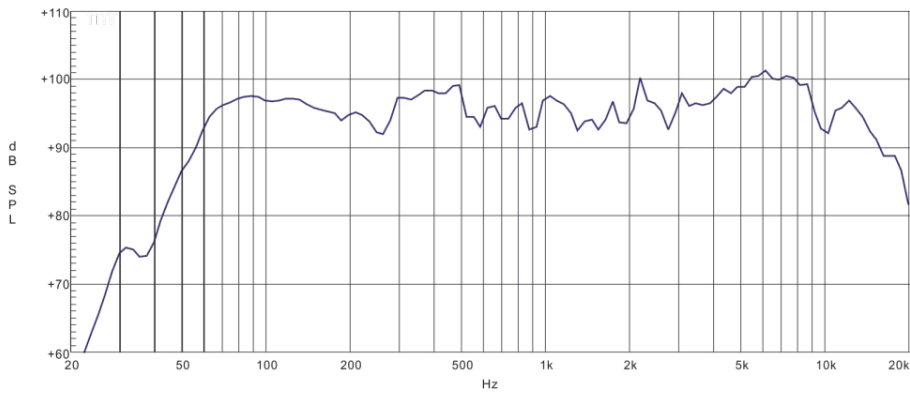

DRX-12A

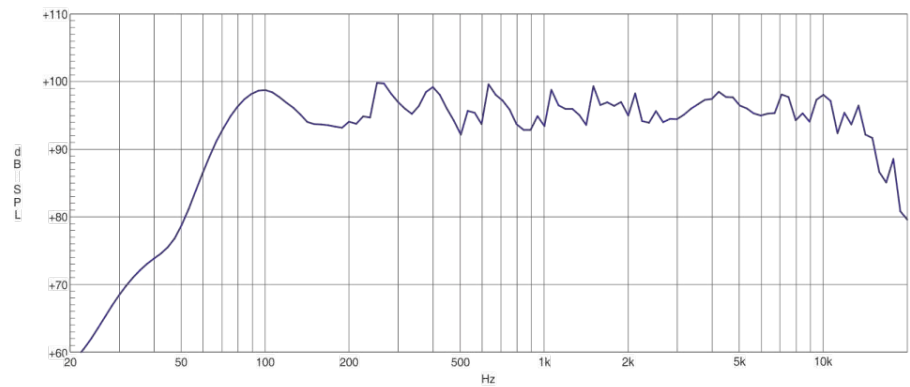

DRX-15A

## Connection Cables

Take care of your cables, always holding them by the connectors and avoiding knots and twists when coiling them: This gives the advantage of increasing their life and reliability. Periodically check your cables. A great number of problems (faulty contacts, ground hum, discharges, etc.) are caused entirely by using unsuitable or faulty cables.

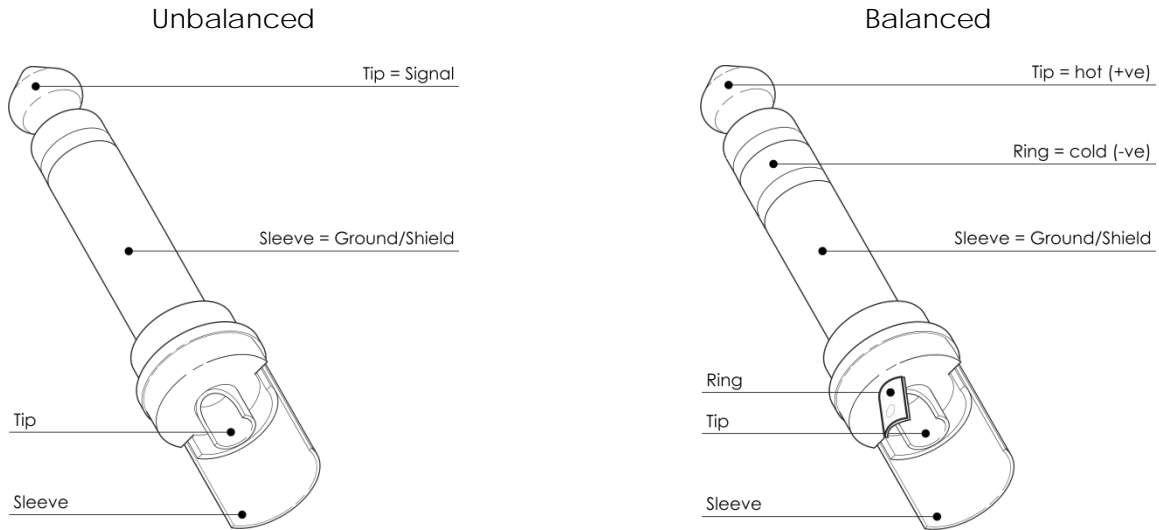

For these applications the unit provides 1/4" TRS and XLR connectors to easily interface with most professional audio devices. Follow the configuration examples below for your particular connection.

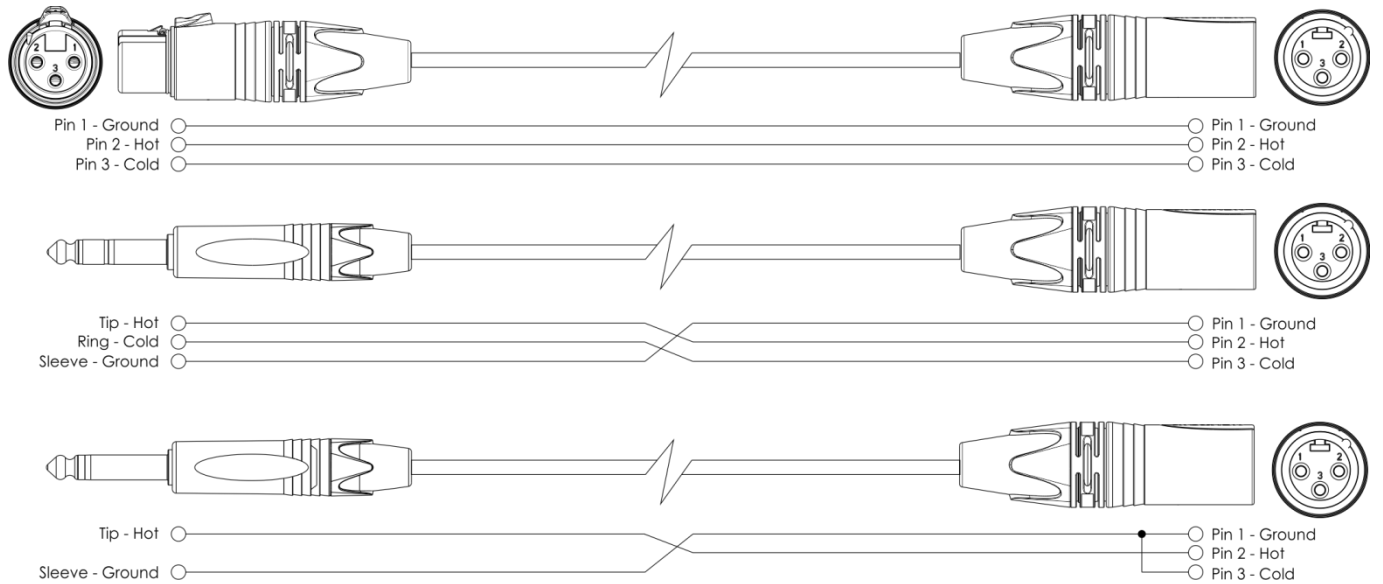

## Technical Specifications

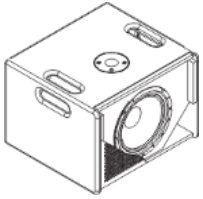

Model Active	<b>DRX-10BA Sub</b>
System Type	10" Active subwoofer Speaker Cabinet
Continuous Power	600W
Frequency Response	50Hz-120Hz(- 6dB)
SPL (1W/1M)	94 dB /121. 8dB Max
Transducer Low	10" woofer -2.5" Voice Coil . with ventilation
Active Crossover	HPF80Hz under analog processor
Input Connectors	L - R(COMBO/ XLR - F) / L- R Link (2 - XLR - M) L - R Output (2 - XLR - M) Balanced (15kOhms)
Input Level	L- R Line Input 0dBu
External Connectors	Volume Control /Power on with Green LE D/Clip Limiter with RED LED/ Ground Lift / Phase Switch / HPF80 Hz Bypass
Power Supply	110-120V/220-240V SO/60Hz
Enclosure	Painted Plywood Cabinet. Black Metal Grille Protection
Enclosure Construction	15mm plywood cabinet, glued and reinforced, resistant black paint; metal grille, rubber foot.
Mounting	One metal standard pole-mount
Dimension (H x W x D)	325 x 465 x 421mm
Net weight	15.46kg/34.08 lbs

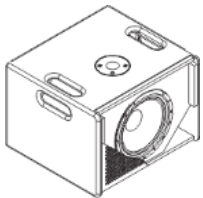

Model Active	<b>DRX-12BA Sub</b>
System Type	12" Active subwoofer Speaker Cabinet
Continuous Power	600W
Frequency Response	47Hz - 125Hz (-6dB)
SPL (1W/1M)	96 dB /123. 8dB Max
Transducer Low	12" woofer - 2.5" Voice Coil. with ventilation
Active Crossover	HPF80Hz under analog processor
Input Connectors	L - R (COMBO/ XLR - F) / L- R Link (2 - XLR - M) L - R Output (2 - XLR - M) Balanced (15kOhms)
Input Level	L - R Line Input 0dBu
External Connectors	Volume Control/Power on with Green LED/Clip Limiter with RED LED/ Ground Lift / Phase Switch / HPF80 Hz Bypass
Power Supply	110-120V/220-240V SO/60Hz
Enclosure	Painted Plywood Cabinet. Black Metal Grille Protection
Enclosure Construction	15mm plywood cabinet, glued and reinforced, resistant black paint; metal grille, rubber foot.
Mounting	One metal standard pole-mount
Dimension (H x W x D)	370 x 530 x 480mm
Net weight	18.6kg/41.01 lbs

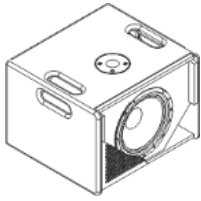

Model Active	<b>DRX-15BA Sub</b>
System Type	15" Active subwoofer Speaker Cabinet
Continuous Power	600W
Frequency Response	45Hz - 125Hz (-6dB)
SPL (1W1M)	97 dB /124.8 dB Max
Transducer Low	15" woofer - 2.5" Voice Coil. with ventilation
Active Crossover	HPF80 Hz under analog processor
Input Connectors	L - R (COMBO/ XLR - F)f L- R Link(2 -XLR - M) L - R Output (2 - XLR - M) Balanced (15kOhms)
Input Level	L - R Line Input 0dBu
External Connectors	Volume Control /Power on with Green LE D/Clip Limiter with RED LED/ Ground Lift / Phase Switch / HPF80 Hz Bypass
Power Supply	110-120V/220 -240V SO/60Hz
Enclosure	Painted Plywood Cabinet. Black Metal Grille Protection
Enclosure Construction	15mm plywood cabinet, glued and reinforced, resistant black paint; metal grille, rubber foot.
Mounting	One metal standard pole-mount
Dimension (H x W x D)	450 x 580 x 480mm
Net weight	22.4 kg/ 49.41 lbs

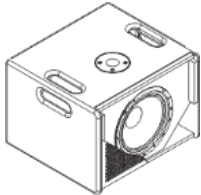

Model Active	<b>DRX-18BA Sub</b>
System Type	18" Active subwoofer Speaker Cabinet
Continuous Power	700W
Frequency Response	40Hz-120Hz(- 6dB)
SPL (1W1M)	98 dB /126dB Max
Transducer Low	18" woofer - 3" Voice Coil with ventilation
Active Crossover	HPF80 Hz under analog processor
Input Connectors	L - R (COMBO/ XLR - F)f L- R Link(2 -XLR - M) L - R Output (2 - XLR - M) Balanced (15kOhms)
Input Level	L - R Line Input 0dBu
External Connectors	Volume Control /Power on with Green LE D/Clip Limiter with RED LED/ Ground Lift / Phase Switch / HPF80 Hz Bypass
Power Supply	110-120V/220 -240V SO/60Hz
Enclosure	Painted Plywood Cabinet. Black Metal Grille Protection
Enclosure Construction	18mm plywood cabinet, glued and reinforced, resistant black paint; metal grille, rubber foot.
Mounting	One metal standard pole-mount
Dimension (H x W x D)	535 x 661 x 515 mm
Net weight	27,4 kg/ 60.41 lbs



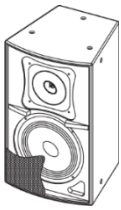

Model	<b>DRX-8A</b>
System	Bi-Amp.
Continuous power	LOW: 150W / HIGH: 25W
Total harmonic distortion	LOW-input/-5dBu 100Hz, out load 40, THD<0.5% HI-input/-8dBu 15kHz, out load 80, THD<0.5%
S/N Ratio	LOW: > 80dBu / HI: > 65dBu
Line input Level	-5dBu ±1 dBu
Input Impedance	Line 15kΩ input
Indicator	Power indicator - CLIP indicator
Power supply	110-120V-60Hz / 220-240V - 50/60Hz
External controls	Volume - Master Switch / AC select
SPL@1m	94dB / 119.5 dB (Max.)
Frequency Response	68Hz - 20kHz - 6dB
Woofers	8" Ø 203mm - 1.5" Voice Coil
Driver	1" Driver - 1" Voice Coil
Horn Coverage (H*V)	50° x 50°
Enclosure Construction	15mm plywood cabinet, glued and reinforced, resistant black paint; metal grille, rubber foot.
Mounting	One ABS plastic standard pole-mount
Dimensions (H x W x D)	542 x 360 x 352mm

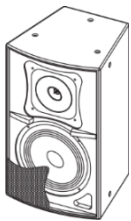

Model	<b>DRX-10A</b>
System	Bi-Amp.
Continuous power	LOW: 170W / HIGH: 25W
Total harmonic distortion	LOW-input/-5dBu 100Hz, out load 40, THD<0.5% HI-input/-8dBu 15kHz, out load 80, THD<0.5%
S/N Ratio	LOW: >80dBu / HI: >65dBu
Line input Level	-5dBu ±1dBu
Input Impedance	Line 15kΩ input
Indicator	Power indicator - CLIP indicator
Power supply	110-120V-60Hz / 220-240V - 50/60Hz
External controls	Volume - Master Switch / AC select
SPL@1m	95dB / 120dB (Max.)
Frequency Response	55Hz - 20kHz - 6dB
Woofers	10" Ø 254mm - 2" Voice Coil
Driver	1" Driver - 1" Voice Coil
Horn Coverage (H*V)	50° x 50°
Enclosure Construction	15mm plywood cabinet, glued and reinforced, resistant black paint; metal grille, rubber foot.
Mounting	One ABS plastic standard pole-mount
Dimensions (H x W x D)	550 x 320 x 328.8mm

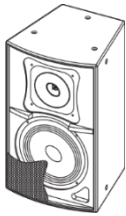

Model	<b>DRX-12A</b>
System	Bi-Amp.
Continuous power	LOW: 200W / HIGH:30 W
Total harmonic distortion	LOW-input/-5dBu 100Hz, out load 40, THD<0.5% HI-input/-5dBu 15kHz, out load 50, THD<0.5%
S/N Ratio	LOW: > 80dBu / HI: > 65dBu
Line input Level	-5dBu ±1dBu
Input Impedance	Line 15kΩ input
Indicator	Power indicator - CLIP indicator
Power supply	110-120V-60Hz / 220-240V - 50/60Hz
External controls	Volume - Master Switch / AC select
SPL@1m	95.6 dB / 122.2 dB (Max.)
Frequency Response	50 Hz - 20kHz - 6dB
Woofer	12" Ø 305 mm - 2" Voice Coil
Driver	1" Driver - 1" Voice Coil
Horn Coverage (H*V)	50° x 50°
Enclosure Construction	15mm plywood cabinet, glued and reinforced, resistant black paint; metal grille, rubber foot.
Mounting	One ABS plastic standard pole-mount
Dimensions (H x W x D)	573.5 x 370.8 x 360mm



Model	<b>DRX-15A</b>
System	2-Way Active Vented Speaker Cabinet
Continuous power	LOW: 220W / HIGH:30 W
Total harmonic distortion	LOW-input/-3dBu 100Hz, out load 4 Ohms , THD<0.5% HI-input/-3dBu 15kHz, out load 8Ohms, THD<0.5%
S/N Ratio	LOW:>80dBu / HI:>70dBu
Line input Level	-5dBu ± 1dBu
Input Impedance	Line 15kΩ input
Indicator	Power ,Clip,Signal
Power supply	115 V 60 Hz / 230 V 50 Hz Switchable
External controls	Volume Control / Power ON with Green LED / Clip Limiter with Red LED/Ground Lift.
SPL@1m	96.5 dB / 123.5 dB (Max.)
Frequency Response	50Hz - 20kHz - 6dB
Woofer	15" Ø 381mm - 2" Voice Coil
Driver	1" Driver - 1" Voice Coil
Horn Coverage (H*V)	50° x 50°
Enclosure Construction	15mm plywood cabinet, glued and reinforced, resistant black paint; metal grille, rubber foot.
Mounting	One ABS plastic standard pole-mount
Dimensions (H x W x D)	522 x 486 x 736mm

## Troubleshooting

---

This troubleshooting guide is meant to help solve simple problems. If a problem occurs, carry out the steps below in sequence until a solution is found. Once the unit operates properly, do not carry out following steps.

1. If the device does not operate properly, unplug the device.
2. Check the fuse, power from the wall, all cables, etc.
3. If all of the above appears to be O.K., plug the unit in again.
4. If you are unable to determine the cause of the problem, do not open the device, as this may damage the unit and the warranty will become void.
5. Return the device to your Dap Audio dealer.





©2015 DAP Audio