

## Series Integrated Screen With IR Remote Control

---

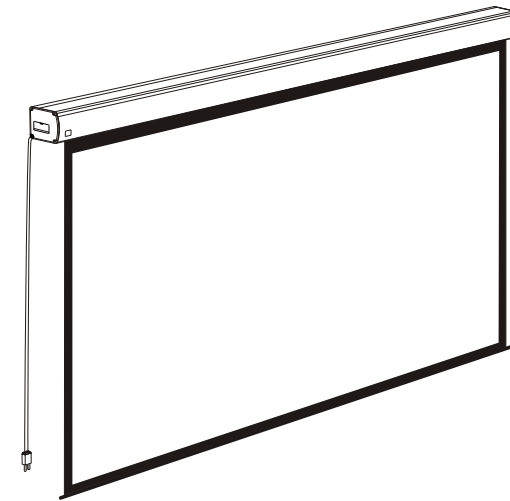

Model: 100360



Before use, please read instructions carefully. After installation, store instructions for future reference.

## Description

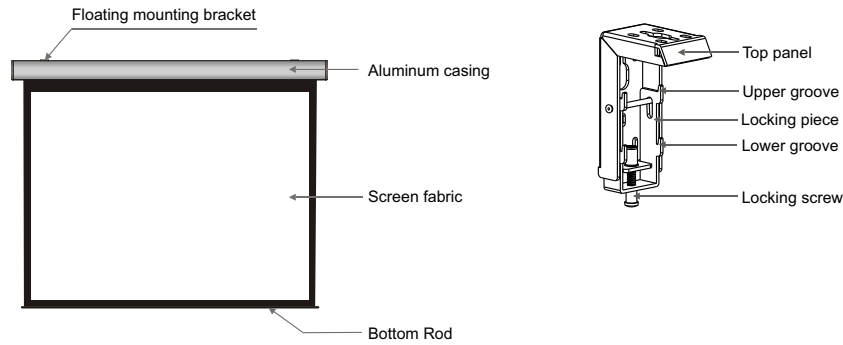

## Accessories

- Floating mounting bracket (2pcs)
- $\varnothing 5 \times 40\text{mm}$  Tapping screw & cap (8sets)
- M5x10 Screw (6pcs)
- Ceiling hanger (2pcs)
- Trigger line ( 1pc )
- External IR receiver ( 1pc )
- Allen key (1pc)
- Remote Controller (1pc)

### Motorized Screen Power Specifications

Voltage	Frequency	Watts	Application
230V/120V/100V	50Hz/60Hz	90W/80W	Applies to motorized screen up to 120"

Please read these important safety instructions

Read and understand all instructions before installing and using the projection screen.

Always connect this projection Screen to a grounded outlet. The power outlet should be located near the Screen and shall be easily accessible.

This equipment must be supplied from a power system providing a PROTECTIVE EARTH connection and having a neutral connection, which can be reliably identified.

Always ensure that the unit is properly earthed and power connections correctly made.

To reduce the risk of electric shock, do not disassemble this projection screen, but take it to a qualified serviceman when service or repair is required. Incorrect reassembly can result in electric shock when used.

Close supervision is necessary when Projection screen is in use by or near children. Do not leave Screen unattended while is use.

Installer must ensure that the mounting structures and fasteners must be of adequate strength to securely support the screen so that vibrations or even abusive pulling on the screen surface will not cause the housing to work loose or fall.

Do no operate screen with a damaged cord or if the screen has been dropped or damaged until it has been examined and repaired by a qualified serviceman

DO not place or attach anything to metal casing or viewing surface of the screen.

Position cord so that it will not be tripped over, pulled or in contact with hot surfaces.

DO not plug the cord with wet hands; electric shock could occur.

Save those instructions

To avoid overheating the motor, do not continually retract and lower the screen for over 4 minutes at a time. If the motor overheats, it will need a cool down time of 2 minutes. The motor does not need any lubricants. The drop and retract limit of the screen is factory preset to an optimal configuration. Please ask your local dealer or professional to adjust settings to avoid damaging the motor.  
Duty cycle: 4Min./30min

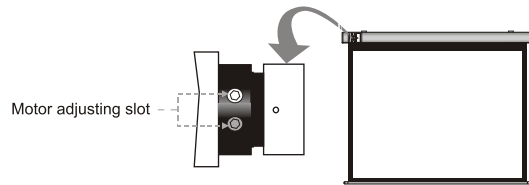

## Warnings

- The warranty will only be valid if you follow the instructions below carefully! Improper use and care may cause serious injury and/or damage!
- Make sure the Fixing screw be fastened when using the wall bracket, to avoid any damage.
- Make sure the surface you have chosen for installing the screen is flat and secure.
- While installing motorized screen, please hire professionals or your local dealer to ensure safety. A wrong connection may lead to fire or leaks.
- If you choose an IR remote control: Ensure that the receiving eye is not pointed directly at a light. This could result in damage and/or malfunction of the receiver; when installing the screen behind a valance, or in the ceiling, make sure to plug in the external IR receiver, and place the receiver outside of the valance or ceiling.
- Please read the following as any damage to the screen surface will affect the quality of the picture:
  1. Avoid contact or touching the screen surface as it may cause scratches or tears.
  2. Do not write or draw on the surface.
  3. Clean the screen with a soft cloth and lukewarm water. Do not use any detergent or cleaning products.
- Roll up the screen after every use. Ensure that the screen is level when installing; do not pull on the sides or fold the screen.
- To prevent unnecessary damage, the operating and maintenance of the screen should be done by adults.
- When the plug on power cord is used as disconnect device, the socket-outlet shall be installed near the equipment and shall be easily accessible

	Ignoring the safety warnings may lead to injuries and/or damaging the product.		Fixtures should be installed in a secure place to avoid accidents or the screen falling.
	Do not connect any electrical attachments or remote controls.		Roll up the screen after every use. Leaving it hanging for a long period of time may cause the fabric to loosen.
	Please contact your local dealer for repairs or maintenance. Please contact our company if you have any further questions. Avoid taking apart the fixtures yourself. Loose parts may cause the screen to fall.		Refrain from hanging anything on the screen as it may cause the screen to fall.

Do not take apart and replace with unknown parts. If there are any problems, please contact your local dealer. Product specifications are subject to change.

## Installation

Take out all the parts from the package and following the accessories guideline ensure all the parts are there. There are three different types of installation available for this product: wall mount, ceiling mount or ceiling hang. Depending on the installation environment, the floating mounting brackets can be installed at various points for your convenience. However, the ideal position for the mounting brackets is closer to the endcap as this will reduce vibration and noise.

### Wall and Ceiling Mount Installation

1. According to the surface of installation, choose the appropriate screws needed for mounting (regular screws for wood surfaces, tapping screws for concrete surfaces)
2. Mount the brackets onto the surface, ensuring it is level (tip: draw a erasable level line when mounting the brackets). See below for picture description (figure 1):

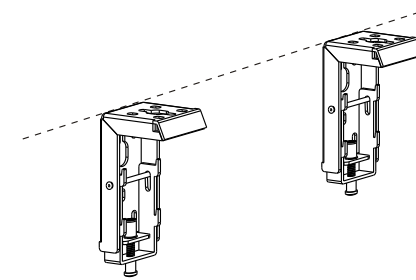

Figure 1

### Installation Steps:

1. Wood wall and ceiling installation: Drill in the  $\phi 5 \times 40$  screws through the appropriate holes in the bracket (figure 2-3)
2. Drywall and ceiling installation: Install the anchors and drill in the  $\phi 5 \times 40$  screws into the appropriate bracket holes (figure 4-5)

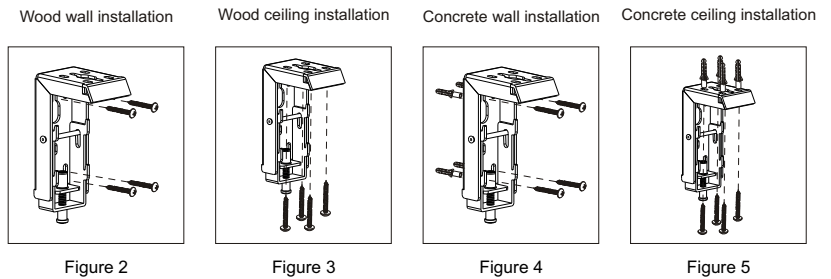

Figure 2

Figure 3

Figure 4

Figure 5

3. Loosen the locking screw to lower the locking piece down all the way (figure 6-7)

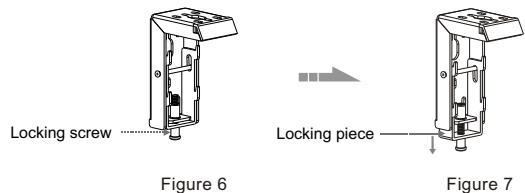

4. When mounting the screen onto the floating mounting brackets, ensure the grooves on the screen casing match up with the upper and lower grooves on the brackets. simply slide in, and the bracket's grooves will hold the casing in place. Horizontal adjustments can still be made (figure 8-10)

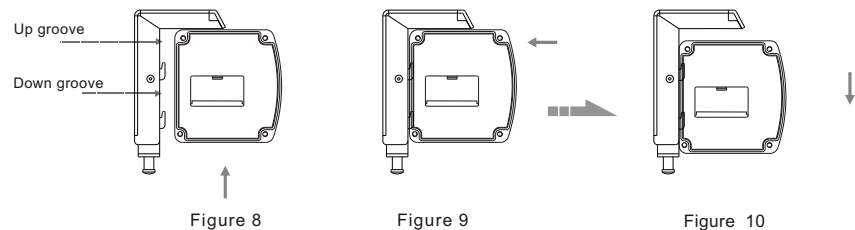

5. To lock the screen in place, close and tighten the locking screw on the mounting brackets. This will keep the screen casing locked firmly in place (figure 11-12).

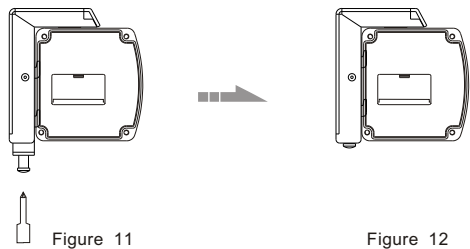

### Other Options Connection Diagram

#### 一. Function Destruction for conversion from FM to IR Control

When you insert the Wireless Synchro Converter Receiver into EXTIR plug of the screen (Figure 45), you can use FM wireless remote control device. The Intelligent Synchro Power Supply Control Adapter (for all projectors), with 12V wireless trigger (for projectors with trigger output), can synchronously control the screen. (Figure 46-47)

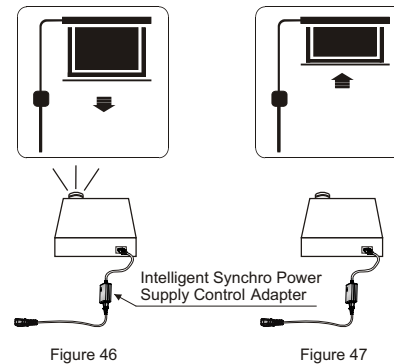
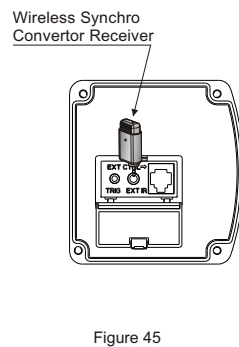

#### 二. External Wall Switch

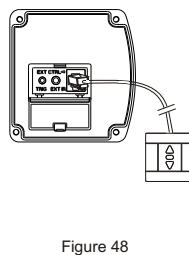

#### 三. External Intelligent Wall Switch Connection

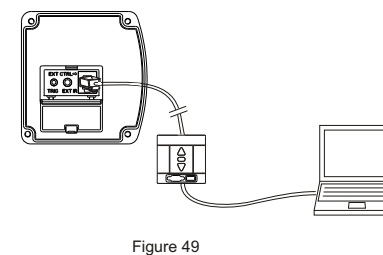

Manual control for screen up/stop/down.

Intelligent control for screen up/stop/down when connected to the intelligent interface of the screen.  
Intelligent control for screen up/stop/down when connected to the computer's RS232 or USB interface.

### Automatic Trigger Control Description

- 1.Insert one end of trigger into the trigger jack at left side of screen's end cap TRIG (Figure 22),, and insert another end into 12V output hole.
- 2.When the projector is running, screen fabric will go down automatically; when the projector is closed, screen fabric will retreat automatically.
- 3.You can remove the 12V trigger wire if there is no need.

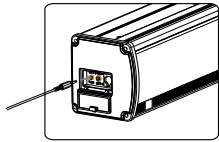

Figure 39

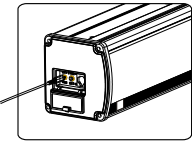

Figure 40

### External Controls (Central Control or RS232, Wall Switch) Function

Plug one side of the signal cord into the computer output jack at left side of the screen's end cap, the other side of the signal cord to the Central Control jack, RS232 or Wall Switch (Figure 41-42), and then you can control the up/stop/down of the screen via central control or computer.

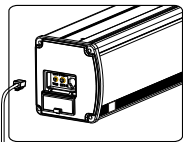

Figure 41

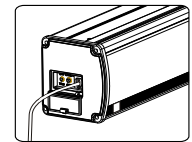

Figure 42

### IR Remote Control Function

- 1.When nothing blocks the sight of IR window, you can use the controller to control the screen (Figure43).
- 2.For hidden installation or IR window is blocked by something, please take out the External IR Receiver and plug its head to the relevant hole, and then fix it at the position where IR signal is available. (Figure 44)

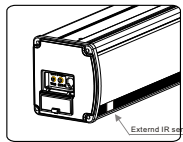

Figure 43

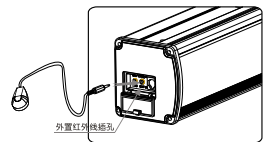

Figure 44

### Ceiling Hang Installation

Choose tapping screws with hangers (or other screws with hangers, not provided) according to your ceiling material. 5 x 40mm for wood ceilings and tapping screws for concrete ceilings are recommended.

- 1.Drill two identical holes with an electrical drill and ensure it is horizontal with the Wall. Fasten hangers (not provided) into the ceiling (figure 13).

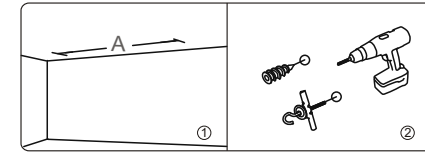

Figure 13

- 2.Use the M5 x 10 screws provided in the accessory package to fix the ceiling hanger into the wall bracket. Ensure the tightening screws on the wall bracket are tightened and secure. (figure 14-15)

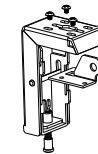

Figure 14

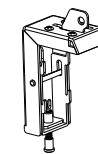

Figure 15

- 3.After inserting the ceiling hanger, ensure the grooves on the case housing match up with the mounting bracket. To secure the case housing into the brackets, tighten the locking screws. (figure 16-17)

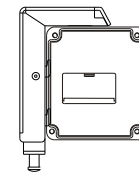

Figure 16

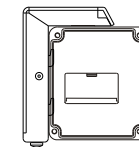

Figure 17

- 4.After completing steps 2 and 3, check to see whether the wall bracket is securely fixed onto the housing of the screen before hanging. Hang screen as shown below. (figure 18)

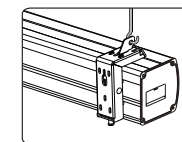

Figure 18

5. Fasten the Fixing screw on the bracket, to fix casing tightly onto the brackets.( Figure 33-34 )

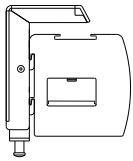

Figure 33

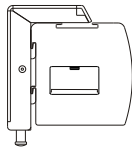
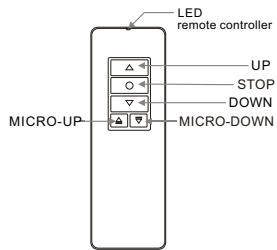

Figure 34

Refer to Page 3 for Suspension hanging.

## Instructions



1GD-IRan

### Controller button instruction

- 1.To raise screen press "UP"
- 2.To hold screen at desired position press "STOP."
- 3.To lower screen press "DOWN."
4. To raise the screen little at your desired position press "MICRO-UP"
5. To lower the screen little at your desired position press "MICRO-DOWN"

### Caution:

- 1.The shortest distance between receiver and controller is 0.5 meter.
- 2.Controller will work within 30 degree away horizontally from the center of receiver point within 8 meters from the screen.
- 3.The controller will not work if the signal was covered by something.
- 4.Keep the controller far away from high temperature and humid situation.
- 5.Please change the battery when the signal is weak.
- 6.Please take the battery out if the controller was not being used for long time.
- 7.Please choose the same type battery as original supplied.

### How to install the battery:

- 1.Turn the controller around, push to open the cover as guide arrow.
- 2.Put the battery in according the guide of cathode and anode.
- 3.Close the cover.

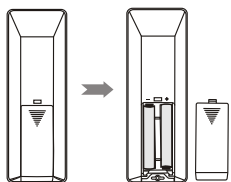

## Operating Instructions

### Function Description

Press down and open the end cap door before using the control interface. Cover up the door if you do not need the external function.

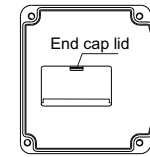

Figure 35

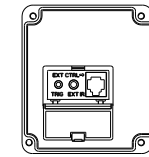

Figure 36

### How to use the Manual/Remote Control Switch Button (Figure 20-21)

This motorized screen has 4 types on control options: infrared (IR) remote control, manual control, triggered control, and external control (central control or RS232/USB).

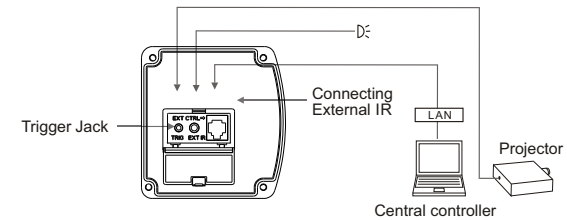
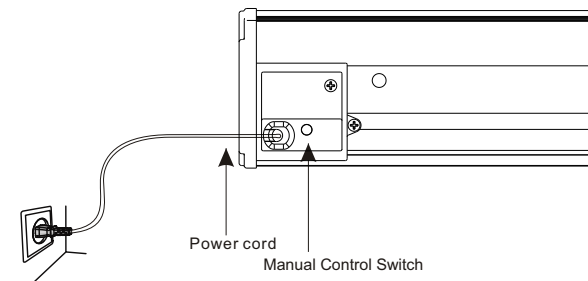

Figure 37

### Manual control switch description



Switch control follows such priority: Down-Stop-Up-Stop-Down.