



MANUAL



ENGLISH

PA-250

V1

Ordercode: D6160

Table of contents

Warning	2
Safety Instructions	2
Operating Determinations	4
Connection with the mains	4
Return Procedure	4
Claims	4
Description of the device	5
Frontside	5
Backside	6
Installation	7
Set Up and Operation	7
Connecting Inputs	7
Connecting Outputs	8
Low Impedance Outputs	8
High Impedance Outputs	8
Connection Cables	9
Maintenance	10
Replacing the Fuse	10
Troubleshooting	10
Product Specifications	11
Notes	12

Warning



**For your own safety, please read this user manual carefully
before your initial start-up!**



Unpacking Instructions

Immediately upon receiving this product, carefully unpack the carton and check the contents to ensure that all parts are present, and have been received in good condition. Notify the dealer immediately and retain packing material for inspection if any parts appear damaged from shipping or the carton itself shows signs of mishandling. Save the carton and all packing materials. In the event that a device must be returned to the factory, it is important that the device is returned in the original factory box and packing.

Your shipment includes:

- DAP Audio PA-250
- Power cable (1,5 m)
- User manual



CAUTION!
Keep this device away from rain and moisture!
Unplug mains lead before opening the housing!



Safety Instructions

Every person involved with the installation, operation and maintenance of this system has to:

- be qualified
- follow the instructions of this manual



CAUTION! Be careful with your operations.
**With a dangerous voltage you can suffer
a dangerous electric shock when touching the wires!**



Before you initial start-up, please make sure that there is no damage caused by transportation. Should there be any, consult your dealer and do not use the system.

To maintain perfect condition and to ensure a safe operation, it is absolutely necessary for the user to follow the safety instructions and warning notes written in this manual.

Please consider that damages caused by manual modifications to the system are not subject to warranty.

This system contains no user-serviceable parts. Refer servicing to qualified technicians only.

IMPORTANT:

The manufacturer will not accept liability for any resulting damages caused by the non-observance of this manual or any unauthorized modification to the system.

- Never let the power cord come into contact with other cables! Handle the power cord and all connections with the mains with particular caution!
- Never remove warning or informative labels from the unit.
- Never use anything to cover the ground contact.
- Never leave any cables lying around.
- Do not insert objects into air vents.
- Do not connect this system to a dimmerpack.
- Do not switch the system on and off in short intervals, as this would reduce the system's life.
- Do not open the device and do not modify the device.
- Do not drive the inputs with a signal level bigger, than required to drive the equipment to full output.
- Do not plug mics into the console (or stagebox) while phantom power is on. Also mute the monitor / Pa system when turning phantom power on or off. Allow the system to adjust for a couple of seconds, before setting the input gains.
- Only use system indoors, avoid contact with water or other liquids.
- Avoid flames and do not put close to flammable liquids or gases.
- Always disconnect power from the mains, when system is not used. Only handle the power cord by the plug. Never pull out the plug by tugging the power cord.
- Always operate the unit with the AC ground wire connected to the electrical system ground.
- Make sure you do not use the wrong kind of cables or defective cables.
- Make sure that the signals into the mixer are balanced, otherwise hum could be created.
- Make sure you use DI boxes to balance unbalanced signals; All incoming signals should be clear.
- Make sure that the available voltage is not higher than stated on the rear panel.
- Make sure that the power cord is never crimped or damaged. Check the system and the power cord from time to time.
- Please turn off the power switch, when changing the power cord or signal cable, or select the input mode switch.
- Extreme frequency boosts in connection with a high input signal level may lead to overdriving your equipment. Should this occur, it is necessary to reduce the input signal level by using the INPUT control.
- To emphasize a frequency range, you do not necessarily have to move its respective control upward; try lowering surrounding frequency ranges instead. This way, you avoid causing the next piece of equipment in your sound path to overdrive. You also preserve valuable dynamic reserve ("headroom").
- Avoid ground loops! Always be sure to connect the power amps and the mixing console to the same electrical circuit to ensure the same phase!
- If system is dropped or struck, disconnect mains power supply immediately. Have a qualified engineer inspect for safety before operating.
- If the system has been exposed to drastic temperature fluctuation (e.g. after transportation), do not switch it on immediately. The arising condensation water might damage your system. Leave the system switched off until it has reached room temperature.
- If your Dap Audio device fails to work properly, discontinue use immediately. Pack the unit securely (preferably in the original packing material), and return it to your Dap Audio dealer for service.
- Repairs, servicing and electric connection must be carried out by a qualified technician.
- For replacement use fuses of same type and rating only.
- **WARRANTY:** Till one year after date of purchase.

Operating Determinations

This system is not designed for permanent operation. Consistent operation breaks will ensure that the system will serve you for a long time without defects.

If this system is operated in any other way, than the one described in this manual, the product may suffer damages and the warranty becomes void.

Any other operation may lead to dangers like short-circuit, burns, electric shock, etc.

You endanger your own safety and the safety of others!

Improper installation can cause serious damage to people and property !

Connection with the mains

Connect the device to the mains with the power-plug.

Always pay attention, that the right color cable is connected to the right place.

International	EU Cable	UK Cable	US Cable	Pin
L	BROWN	RED	YELLOW/COPPER	PHASE
N	BLUE	BLACK	SILVER	NEUTRAL
	YELLOW/GREEN	GREEN	GREEN	PROTECTIVE GROUND

Make sure that the device is always connected properly to the earth!

Improper installation can cause serious damage to people and property!



Return Procedure



Returned merchandise must be sent prepaid and in the original packing, call tags will not be issued. Package must be clearly labeled with a Return Authorization Number (RMA number). Products returned without an RMA number will be refused. Highlite will not accept the returned goods or any responsibility. Call Highlite 0031-455667723 or mail aftersales@highlite.nl and request an RMA prior to shipping the fixture. Be prepared to provide the model number, serial number and a brief description of the cause for the return. Be sure to properly pack fixture, any shipping damage resulting from inadequate packaging is the customer's responsibility. Highlite reserves the right to use its own discretion to repair or replace product(s). As a suggestion, proper UPS packing or double-boxing is always a safe method to use.

Note: If you are given an RMA number, please include the following information on a piece of paper inside the box:

- 01) Your name
- 02) Your address
- 03) Your phone number
- 04) A brief description of the symptoms

Claims

The client has the obligation to check the delivered goods immediately upon delivery for any short-comings and/or visible defects, or perform this check after our announcement that the goods are at their disposal. Damage incurred in shipping is the responsibility of the shipper; therefore the damage must be reported to the carrier upon receipt of merchandise.

It is the customer's responsibility to notify and submit claims with the shipper in the event that a fixture is damaged due to shipping. Transportation damage has to be reported to us within one day after receipt of the delivery.

Any return shipment has to be made post-paid at all times. Return shipments must be accompanied with a letter defining the reason for return shipment. Non-prepaid return shipments will be refused, unless otherwise agreed in writing.

Complaints against us must be made known in writing or by fax within 10 working days after receipt of the invoice. After this period complaints will not be handled anymore.

Complaints will only then be considered if the client has so far complied with all parts of the agreement, regardless of the agreement of which the obligation is resulting.

Description of the device

Features

The DAP PA-250 is a 250W, 100V plain amplifier. It is a reliable workhorse that can be used for many applications. Inputs can be connected with terminals, balanced XLR or unbalanced RCA connectors. The loop through is available to connect external audio processing, like equalizing enhancing or feedback killers. The PA-500 can extend a DAP 100V PA system or be used for mobile rental applications. It can also be combined with line mixers in a situation where 100V is an extension of a commercial audio installation.

USP

- Power consumption: 250W
- 100V & 8Ω: Terminals
- Line input: RCA, XLR & terminals
- Loop through: RCA
- Headphones: 6,3 mm jack

Inputs

- 1 x Line: RCA, XLR & terminals

General

- Power supply: 230V AC, 50 Hz
- Back-up power supply: 24V DC
- Power consumption: 500W
- Power connection: IEC power connector
- Fuse: T4AL/250V
- Dimensions: 330 x 482 x 95 mm (LxWxH)
19" x 2HE
- Weight: 12 kg

Frontside

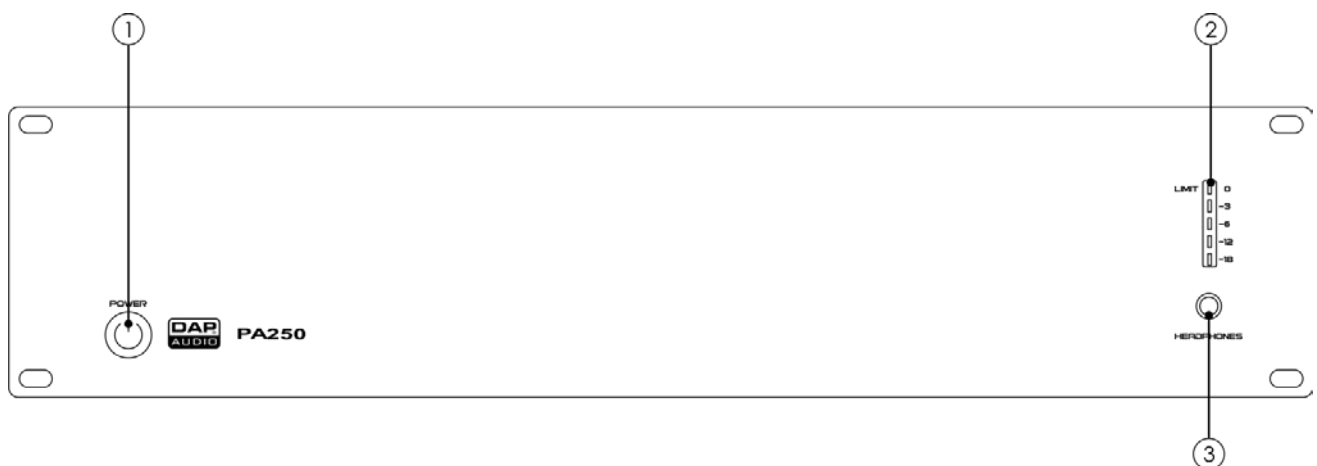

Fig. 01

- 1 Power switch ON/OFF**
 Press the button to switch the device ON/OFF.
- 2 VU meter**
 The clip LED indicates peak levels at the output of the amplifier. If the red LED frequently blinks or lights continuously, the output is likely to enter clipping. If this happens, we strongly suggest decreasing the signal source volume.
- 3 Headphones 6,3 mm jack IN**
 Use this connector to connect 6,3 mm jack headphones.

Backside

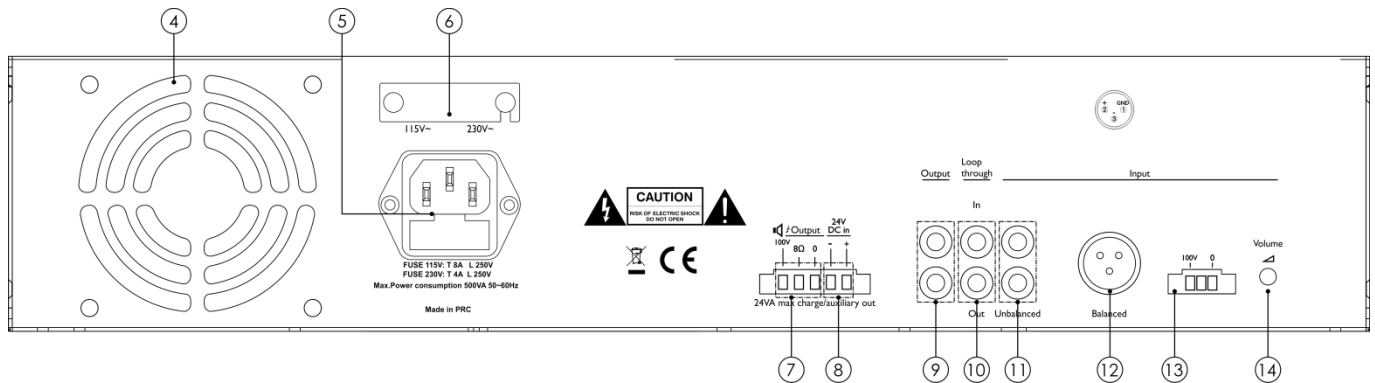

Fig. 02

- 4 Cooling fan**
Do not obstruct the air inlet.
- 5 IEC power connector 230V AC + fuse T4AL/250V**
Connect the device to the appropriate power supply.
- 6 AC selector**
Before connecting your PA-250 to the mains, make sure that the AC selector is set to the proper voltage which is used in your country. In case of doubt, consult a technician.
- 7 100V/8Ω terminal connector OUT**
If you connect a 100V speaker, connect the main feed cable to the 100V terminal and the common cable to the 0 terminal.
If you connect a low impedance speaker, then connect the main feed cable to the 8Ω terminal and the common cable to the 0 terminal.
- NOTE:** Do not connect the 100V and 8Ω speakers at the same time.
- 8 24V DC IN terminal connector**
This input can be used in mobile applications, such as boats where 120 or 230V AC is not available or in applications that must continue to operate in case of power shortage. When a 24V DC battery is connected, the unit will operate on the supplied DC voltage. The amplifier has a built-in charger, which charges the connected battery.
- 9 Unbalanced RCA line level OUT**
Use this connector to provide a dedicated output source for another device.
- 10 Loop through RCA IN/OUT**
Loop through input and output connections allow external sound processing equipment to be connected between the preamplifier and the power amplifier stages.
- 11 Unbalanced RCA line level IN**
Use this connector to connect unbalanced signal source.
- 12 XLR balanced connector IN**
Use this connector to connect balanced signal source.

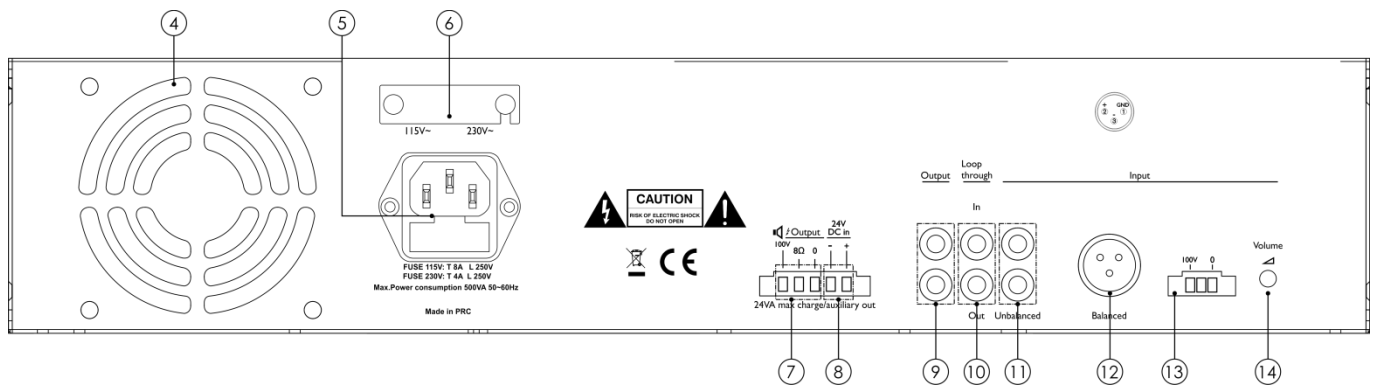

Fig. 03

13 100V terminal input connector

Connect the main feed cable from your 100V signal source to the 100V terminal. Connect the common cable to the 0 terminal.

14 Volume control

Turn the control to adjust volume.

Installation

Remove all packing materials from the PA-250. Check if all foam and plastic padding is removed. Secure the equipment into a 19" rack if preferred. Connect all cables.

**Always disconnect from electric mains power supply before cleaning or servicing.
Damages caused by non-observance are not subject to warranty.**

Set Up and Operation

Before plugging the unit in, always make sure that the power supply matches the product specification voltage. Do not attempt to operate a 115V specification product on 230V power, or vice versa.

Before powering up the first time, make sure that the AC selector is set to the proper voltage!

Damage caused by connecting the amplifier to improper AC voltage is not covered by any warranty!

⚠ Always turn off and disconnect the amplifier from mains voltage before making audio connections. The attenuators should always be turned down during power-up. ⚠

Connecting Inputs

Use the XLR input connector on the rear to supply audio signals to your DAP Audio PA-250 amplifier. The RCA connectors accept unbalanced audio connections while the XLR connector accepts balanced audio connections.

Connecting Outputs

Speakers are connected by means of terminal connectors. See the examples below.

Low Impedance Outputs

You can use as many speakers as you want as long as the total impedance matches the amplifiers output.

Example 1: Using the 8Ω output with an 8Ω speaker.

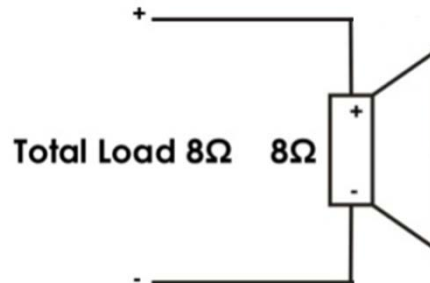

Fig. 04

Example 2: Using the 8Ω output with two 4Ω speakers.

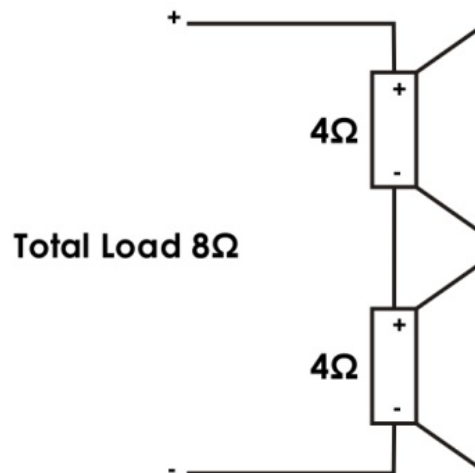





Fig. 05

 In a low impedance system, the total speaker load should always match the amplifier's impedance, in order not to overload the amplifier. The total speaker power should be at least equal to the power of the amplifier, to avoid speaker damage. 

High Impedance Outputs

While using either the 70V outputs or the 100V outputs, note that all speakers **should be wired in parallel**.

 The total power of all speakers summed together should never exceed the total power of the amplifier in a 70V or a 100V system! 

Connection Cables

Take care of your cables, always holding them by the connectors and avoiding knots and twists when coiling them: This gives the advantage of increasing their life and reliability. Periodically check your cables. A great number of problems (faulty contacts, ground hum, discharges, etc.) are caused entirely by using unsuitable or faulty cables.

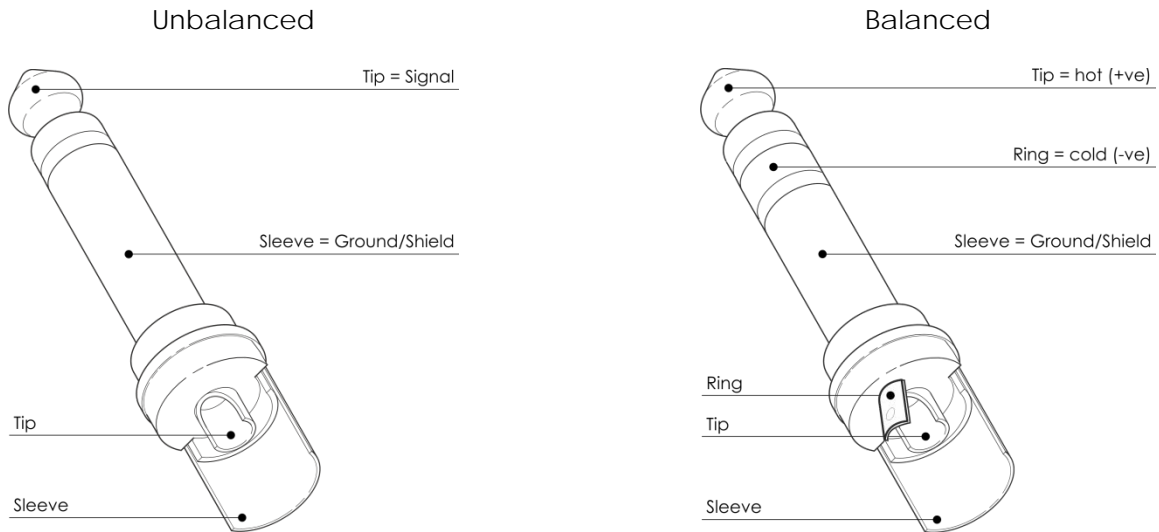

For these applications the unit provides 1/4" TRS and XLR connectors to easily interface with most professional audio devices. Follow the configuration examples below for your particular connection.

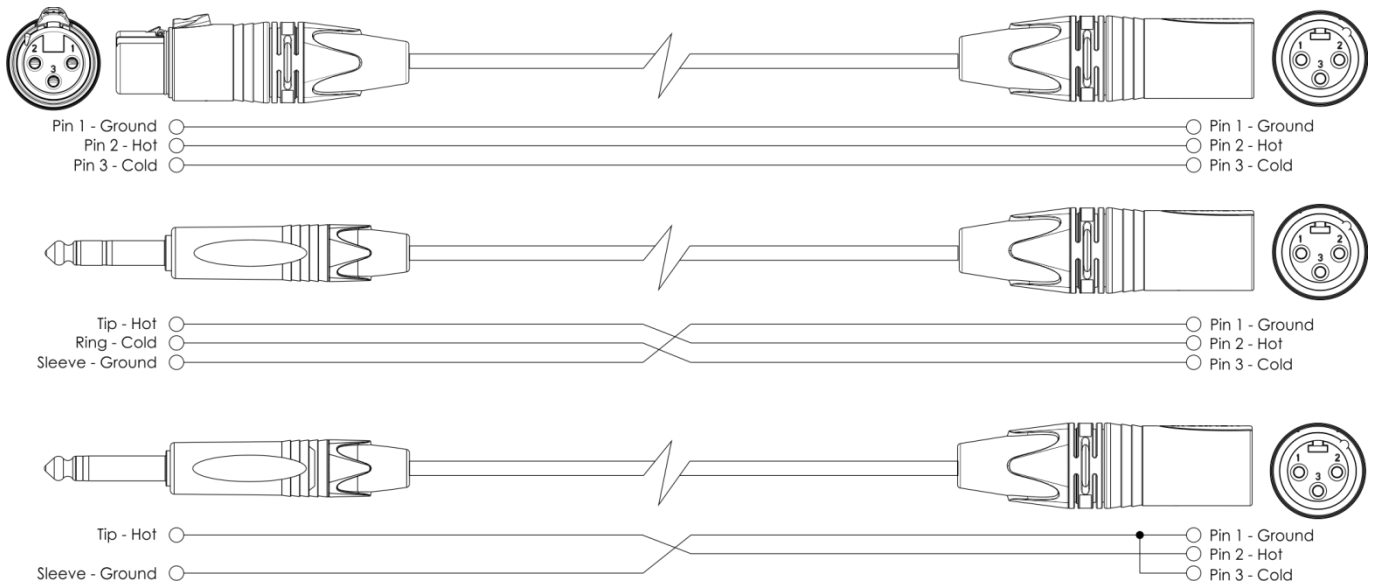

Maintenance

The DAP Audio PA-250 requires almost no maintenance. However, you should keep the unit clean. Disconnect the mains power supply, and then wipe the cover with a damp cloth. Do not immerse in liquid. Do not use alcohol or solvents.

Keep connections clean. Disconnect electric power, and then wipe the audio connections with a damp cloth. Make sure connections are thoroughly dry before linking equipment or supplying electric power.

Replacing the Fuse

Power surges, short-circuit or inappropriate electrical power supply may cause a fuse to burn out. If the fuse burns out, the product will not function whatsoever. If this happens, follow the directions below.

- 01) Unplug the unit from electric power source.
- 02) Insert a screwdriver into the slot in the fuse cover. Gently pry up the fuse cover. The fuse will come out.
- 03) Remove the used fuse. If brown or unclear, it is burned out.
- 04) Insert the replacement fuse into the holder where the old fuse was. Reinsert the fuse cover. Be sure to use a fuse of the same type and specification. See the product specification label for details.

Troubleshooting

DAP Audio PA-250

This troubleshooting guide is meant to help solve simple problems. If a problem occurs, carry out the steps below in sequence until a solution is found. Once the unit operates properly, do not carry out following steps.

- 01) If the device does not operate properly, unplug the device.
- 02) Check power from the wall, all cables, connections, etc.
- 03) Replace the fuse. See page 10 for replacing the fuse.
- 04) If all of the above appears to be O.K., plug the unit in again.
- 05) If nothing happens after 30 seconds, unplug the device.
- 06) Return the device to your DAP Audio dealer.

Product Specifications

USP

- Power consumption: 250W
- 100V & 8Ω: Terminals
- Line input: RCA, XLR & terminals
- Loop through: RCA
- Headphones: 6,3 mm jack

Inputs

- 1 x Line: RCA, XLR & terminals

General

- Power supply: 230V AC, 50 Hz
- Back-up power supply: 24V DC
- Power consumption: 500W
- Power connection: IEC power connector
- Fuse: T4AL/250V
- Dimensions: 330 x 482 x 95 mm (LxWxH)
19" x 2HE
- Weight: 12 kg

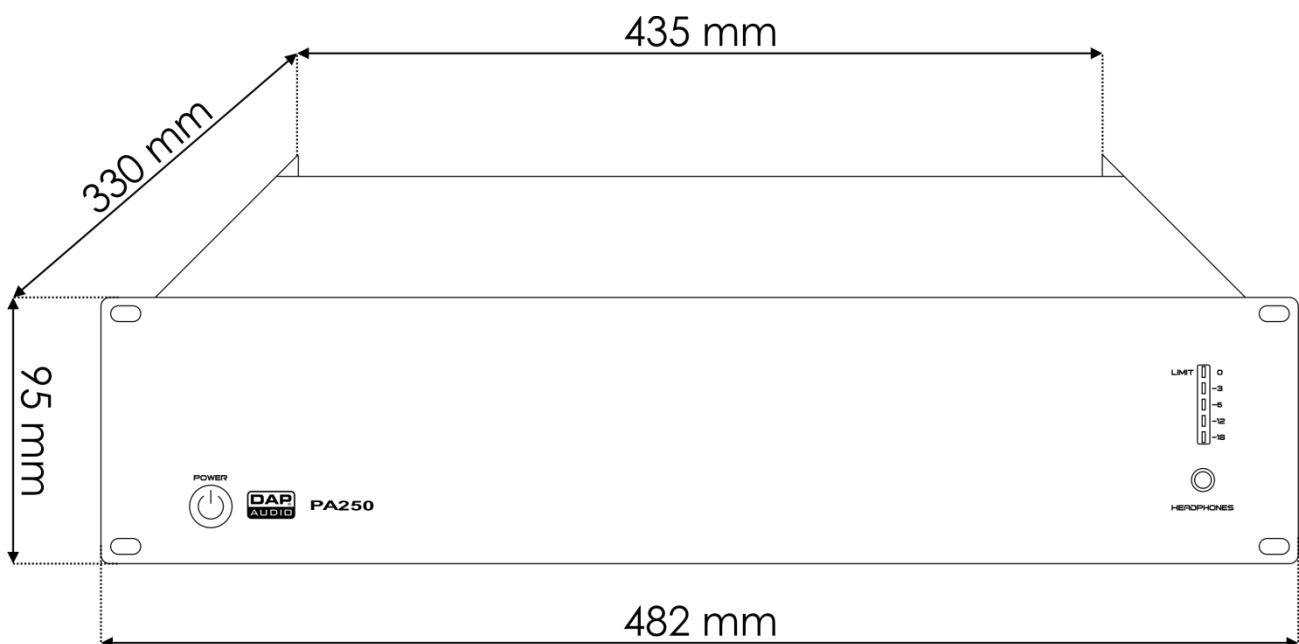

Design and product specifications are subject to change without prior notice.



Website: www.Dap-audio.info
Email: service@highlite.nl



©2016 DAP Audio